

# ALTEN'S

FOUNDRY & MACHINE WORKS

# ALTEN'S FOUNDRY & MACHINE WORKS, LANCASTER, OHIO

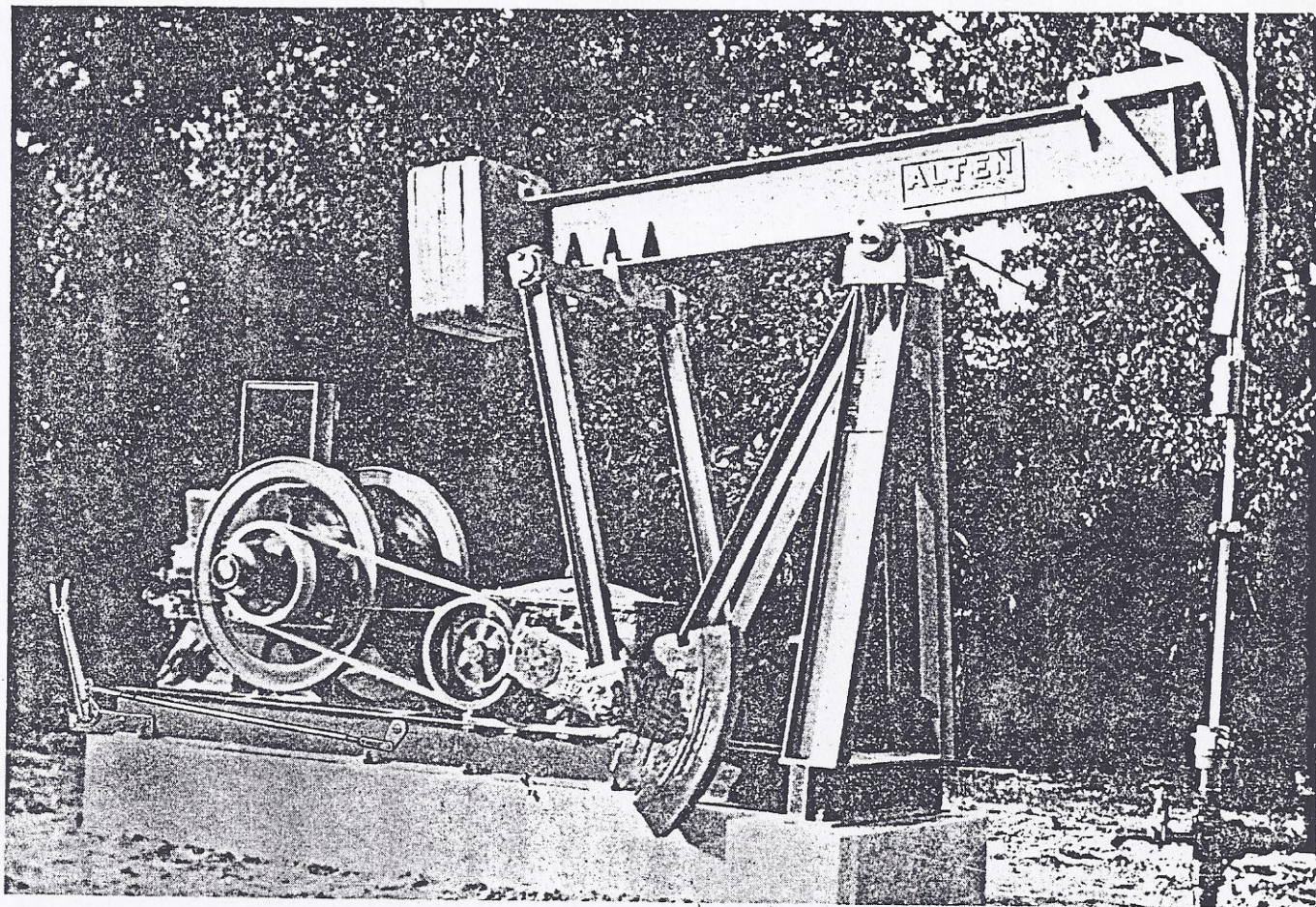

## ALTEN PUMPING UNITS

### ADVANTAGES

Field transportation and installation held to a minimum due to self-contained, unit type skid base which gives maximum strength with minimum weight and also eliminates necessity of an expensive foundation.

Housing necessity minimized, entire unit of weatherproof construction.

High mechanical efficiency due to helical gearing and Timken equipped double reduction reducer. Shafer self-aligning roller bearings used both on wrist pin and equalizer. Straight polished rod lift obtained through arc type hanger. Hanger may be tipped back for well servicing.

Effective balancing is obtained through the Master and Auxiliary Crank Weights in connection with the sectional beam weights.

Stroke lengths and pumping speeds adjustable to maximum efficiency.

Unit constructed for use with any type multi-cylinder engine or electric motor.

All bearings and working parts easily accessible for inspection and lubrication.

Reliable brake for stopping and holding load in any position.

### CONSTRUCTION

#### Samson Post and Frame Assembly

Unit is fabricated from heavy structural steel sections, rigidly electric welded into one integral structure.

#### Saddle and Bearings

The Saddle is fabricated of heavy steel shafting and plate rigidly welded. Bearing housings are machined heavy semi-steel castings equipped with high quality anti-friction bronze-bushings. These housings are spherical for axial bearing alignment. Bearings are provided with Zerk fittings and seals to retain the grease.

#### Walking Beam and Beam Hanger Assembly

The walking beam is a C.B. section reinforced with webbed stiffeners. The arc type hanger assures straight lift for moderate speeds. Head may be folded back for well servicing. The polished rod clamp is of the heavy duty type with extra flexible wire rope attached by splentering.

#### Reduction Unit

The unit incorporated in this design is of the double reduction type. The primary and intermediate pinions are made of Chrome-Nickel steel forged integral with shaft, case hardened and ground. The driven gears are made of medium carbon steel castings, heat treated to the proper hardness. All gears are set up in a lapping machine and run to the proper center distances, thereby insuring good tooth contact. The crank shaft is made from a Chrome-Molybdenum steel forging. All shafts are mounted in high capacity Timken Tapered Roller Bearings.

#### Crank — Pitman — Equalizer Assembly

The design of this unit is such that any minor misalignments are readily and satisfactorily corrected.

The wrist pin and upper pitman bearings are of identical design. Double row Shafer spherical roller bearings were selected for long trouble-free life. These bearings are flood or Zerk lubricated and protected by Victor oil seals. Pitman Shafts are heavy I beam sections with a steel plate welded to either end of beam. Semi-steel bearing housings are assembled to Pitman beams with U bolts, thereby permitting changing of wrist pins in holes without removing the entire Pitman assembly.

The equalizer beam is a heavy steel forging mounted in plain pillow blocks bolted to the walking beam.

The cranks are heavy semi-steel castings. Master and auxiliary weights may be bolted to these cranks.

ALTEN'S FOUNDRY & MACHINE WORKS, LANCASTER, OHIO

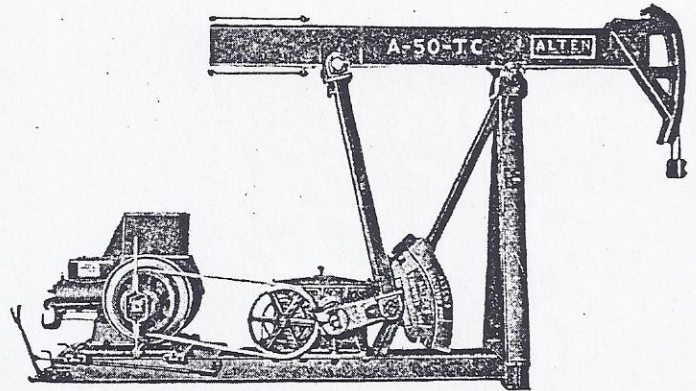
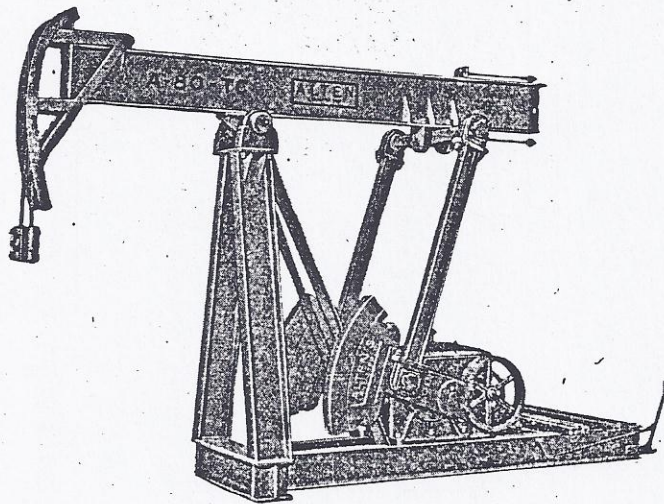
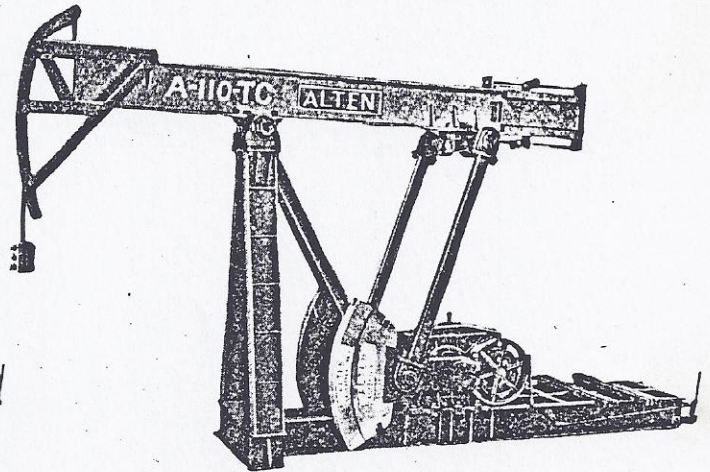
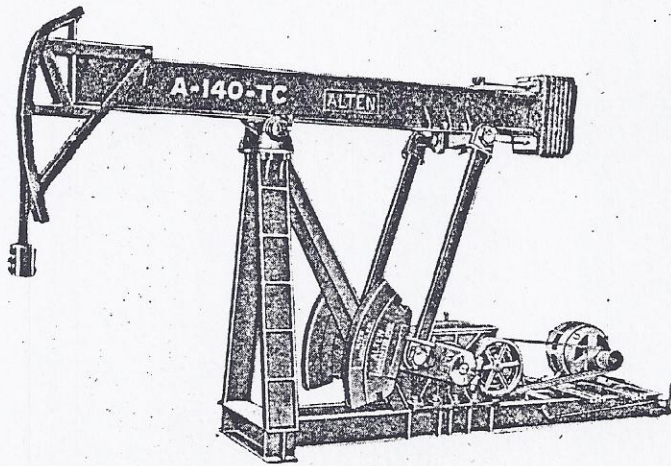

ALTEN PUMPING UNITS

General Specifications

DESCRIPTION	A-140-TC	A-110-TC	A-80-TC	A-50-TC
Unit Structure Rating, API, pounds.....	14,000	11,000	7,500	5,100
Unit Gear Peak Torque Rating, API, inch pounds.....	89,000	70,000	44,550	24,750
Reduction Unit Ratio.....	32.48:1	31.74:1	28.4:1	28.4:1
Range of Polished Rod Strokes, inches.....	32"-38" 45"-54"	28"-32" 38"-44"	22"-26" 30"-36"	18"-21" 27"-30"
Maximum Counterweight Effect at Maximum Polished Rod Stroke, pounds..	8,308	7,165	4,523	3,593
Pitch Diameter of V Belt Sheave.....	20"-7B	20"-5B	16.6"-4B	16"-3B
Walking Beam Size and Weight.....	16"-64lbCB	14"-48lbCB	12"-28lbCB	10"-21lbCB
Well End Working Centers, inches.....	74	64	48	42
Weight of Master Crank Weights per pair, pounds.....	880	730	310	192
Weight of Auxiliary Crank Weights per pair, pounds.....	620	490	220	196
Weight of Beam Weights each, pounds.....	186	178	120	110
Total Weight of Unit with Crank Weights, Engine Slide Rails, less Beam Weights and Engine, pounds.....	8,250	6,560	3,530	2,300

# ALTEN'S FOUNDRY & MACHINE WORKS, LANCASTER, OHIO

## SELECTION AND CARE OF ALTEN PUMPING UNITS

It is highly important in selecting the correct pumping unit for each installation that the following data be considered:

1. Depth of well.
2. Size of plunger.
3. Sucker rod size.
4. Estimated daily production in bbls. (oil and water).
5. Hours of operation per 24-hour day.
6. Fluid level.
7. Gravity of fluid.
8. Tubing size.
9. Gas pressure.

With this information we can recommend the exact unit to provide greater pumping efficiency. We maintain service representatives in most producing fields to help you select the proper unit. In addition, the factory maintains an Engineering Department which is always at your service.

The charts in this catalog are also included in our Bulletin P-105, copies of which are available.

Chart VII which covers production may first be used to get a rough idea as to what stroke and pumping speed will do the job. The plunger diameter and production are known. Working from this information you may determine the two factors mentioned above.

It is important that the length of stroke chosen be somewhat longer than indicated by the chart in order to allow for loss due to rod and tubing stretch. It is also important that this stroke correspond to some standard unit pumper stroke. With these fac-

tors in mind the problem may now be carried through the charts in numerical order.

In all cases the known factors with the use of a straight edge will indicate the unknown. Should the solution be in error, make slight changes in the direction desired and again carry the problem through the charts. With a little practice it becomes a simple problem of mechanics to operate these charts.

### INSTALLATION

Good installation demands:

1. Massive, solid foundation.
2. Foundation should be level.
3. Unit must be securely bolted to foundation.
4. Well center must be accurately measured.
5. Walking Beam must be centered over well.
6. Unit must be properly balanced.
7. Prime mover must be of proper size.
8. "V" belt drive must be accurately aligned.
9. Adjust belts to manufacturer's recommendation.

### SERVICE

With proper selection, installation and care, Alten's Pumping Units will give many years of dependable service. We recommend that users:

1. Inspect and lubricate all unit structure bearings weekly. (Summer No. 3, Winter No. 1 grease as per our lubrication chart furnished to all dealers. Do not use hard cup greases.)
2. Inspect unit reducer oil level weekly.
3. Use only unit reducer oils recommended by the manufacturer of these units. Our dealers have these charts.
4. Check all bolts periodically. Do not allow parts to become loose.

### INSTRUCTIONS FOR USING CHARTS ON TWO FOLLOWING PAGES

For an example assume the following conditions:

Depth of Well.....	2500 feet
Plunger Diameter.....	1 3/4"
Sucker Rod Size.....	5/8"
Strokes per Minute.....	20
Length of Stroke.....	34"
Tubing Size.....	2"

Chart I—To find the Static Polish Rod Load:

Column A—Locate 2500 feet  
 Column C—Locate 5/8" Rods and 1 3/4" Plunger  
 Draw a line between these points. Where line crosses Column B is the Static Polish Rod Load = 5,550 lbs.

Chart II—To find the Acceleration Factor:

Column A—Locate 20 s.p.m.  
 Column C—Locate 34" Stroke  
 Draw a line between these points. Where line crosses Column B is the Acceleration Factor = 1.126

Chart III—To find Polish Rod Load in Pounds:

Column A—Locate 5,550 lbs. Static Load (from Chart I)  
 Column C—Locate 1.126 Acceleration Factor (from Chart II)

A line connecting these two points will cross Column B at 6,230 lbs., the Polish Rod Load.

Chart IV—To find the Torque Rating:

Draw a line from 6,230 lbs. on Column A to 34" stroke on Column C. This line will cross Column B at 42,000 in. lbs. which will be the Torque Rating of the well.

Chart V—To find Loss of Stroke Due to Rod and Tubing Stretch:

Draw a line from 1 3/4" Plunger on Column A to

5/8" Rod and 2" Tubing on Column C. This line will cross Column B at 1.74.

The Loss in Stroke Due to Rod and Tubing Stretch =

$$C \times \left( \frac{D}{1000} \right)^2 = 1.74 \times \left( \frac{2500}{1000} \right)^2 = 10.9"$$

This loss is then to be subtracted from the stroke = 34 - 10.9 = 23.1"

Chart VI—To find Over-Travel of Plunger Due to Acceleration:

Draw a line from 2,500-foot depth on Column A to 20 s.p.m. on Column C. This line crosses Column B at .0485.

Over-Travel of Plunger =  $C_T \times$  Polish Rod Stroke = .0485  $\times$  34 = 1.65"

This figure is to be added to the Polish Rod Stroke.

Theoretical Polish Rod Stroke at the Bottom of the Well = 34 - 10.9 (Chart V) + 1.65" (Chart VI) = 24.75"

Chart VII—To find the Production in Bbl. per Hour draw a line from 1 3/4" Plunger on Column A to 20 s.p.m. on Column C. From the point where this line crosses Column B draw a line to 24.75" stroke on Column E. This line crosses Column D at 7.3 which is the Barrels per Hour Production at 100% efficiency.

Chart VIII—To find the Horse Power Required:

Draw a line from 7.3 Barrels per Hour on Column A to 2,500-foot Depth on Column C. This line crosses Column B at 7.3 h.p. for Multi-cylinder Engines and 5.6 h.p. for Single Cylinder Engines with heavy fly-wheels.

# ALTEN'S FOUNDRY & MACHINE WORKS, LANCASTER, OHIO

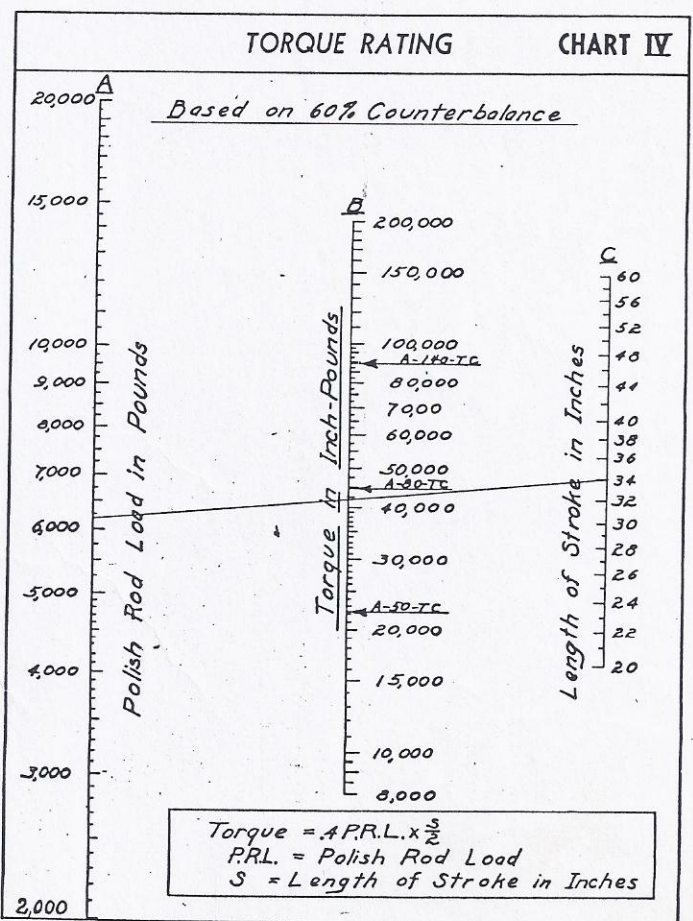
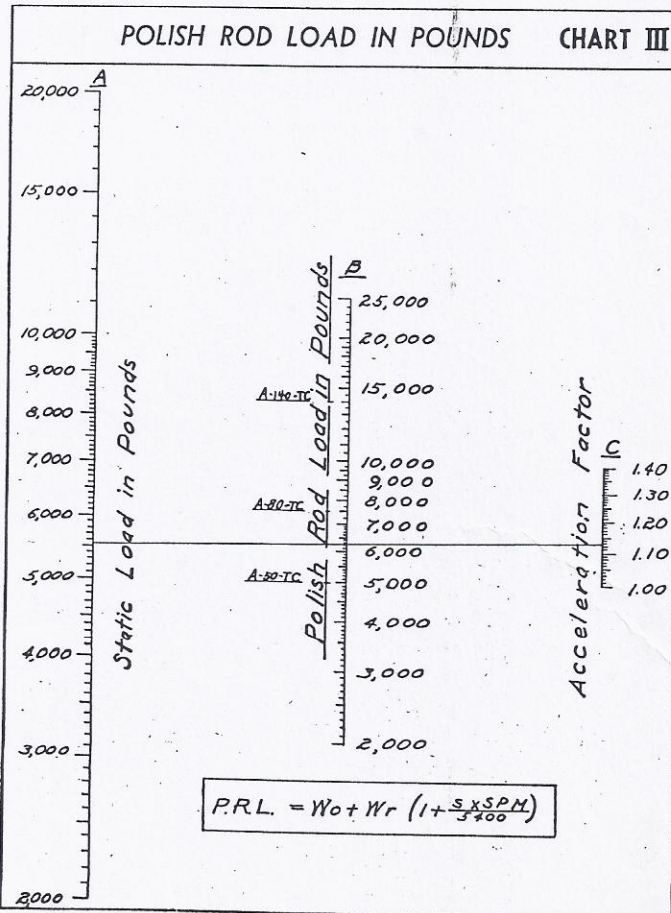
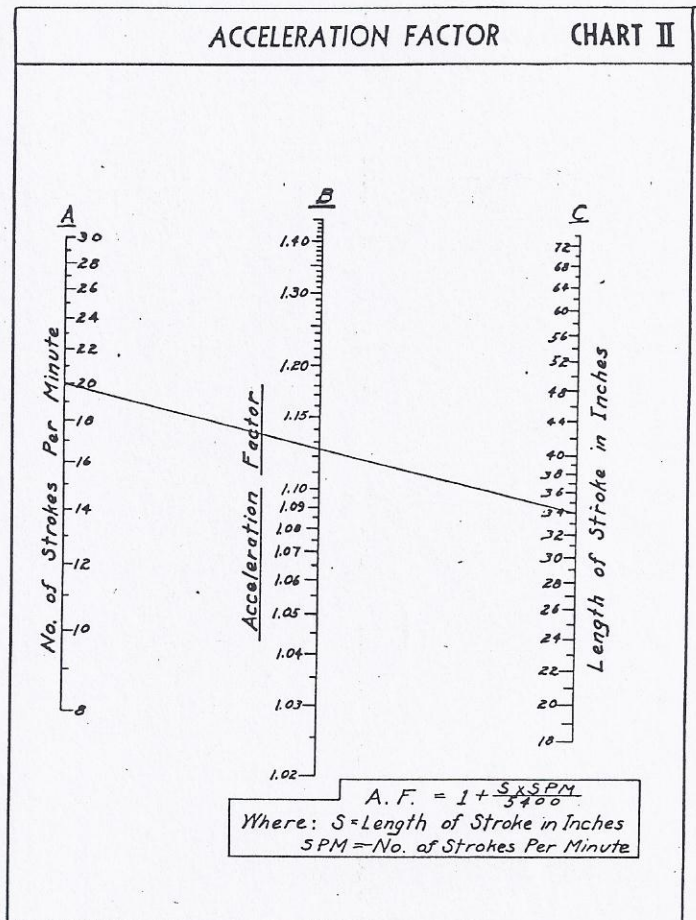
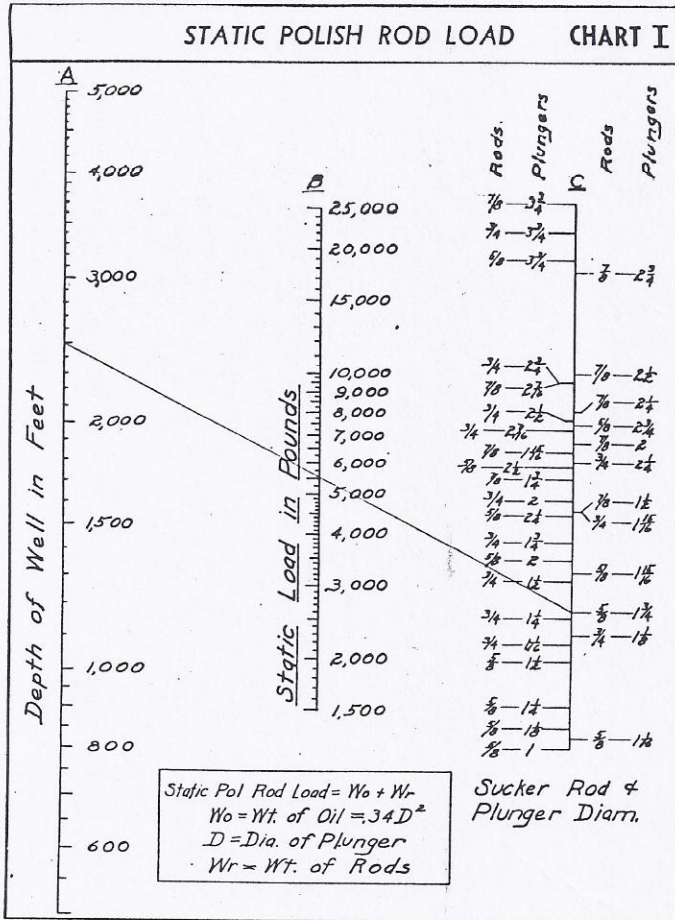

# ALTEN'S FOUNDRY & MACHINE WORKS, LANCASTER, OHIO

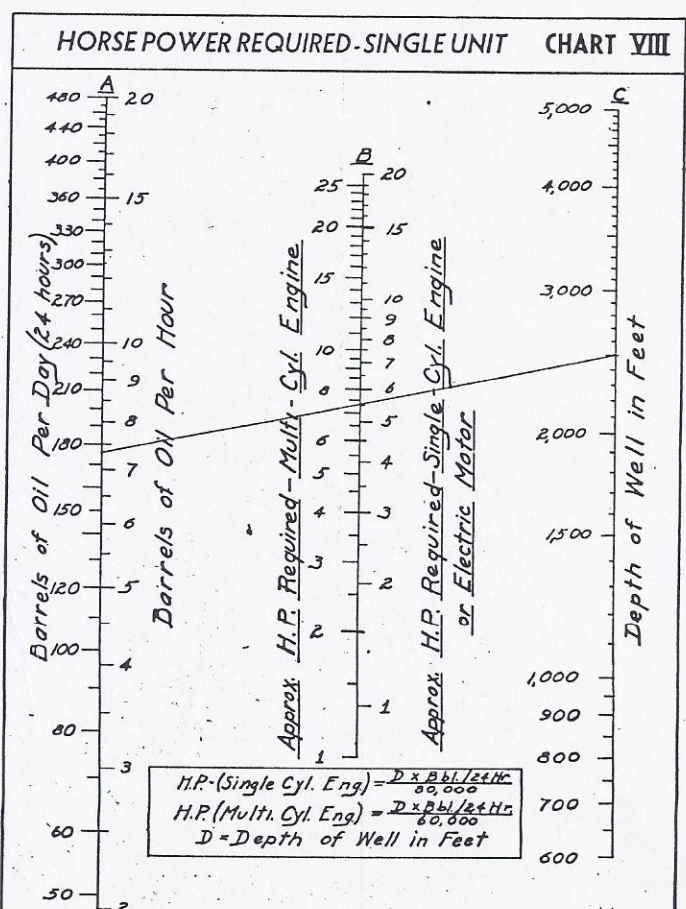
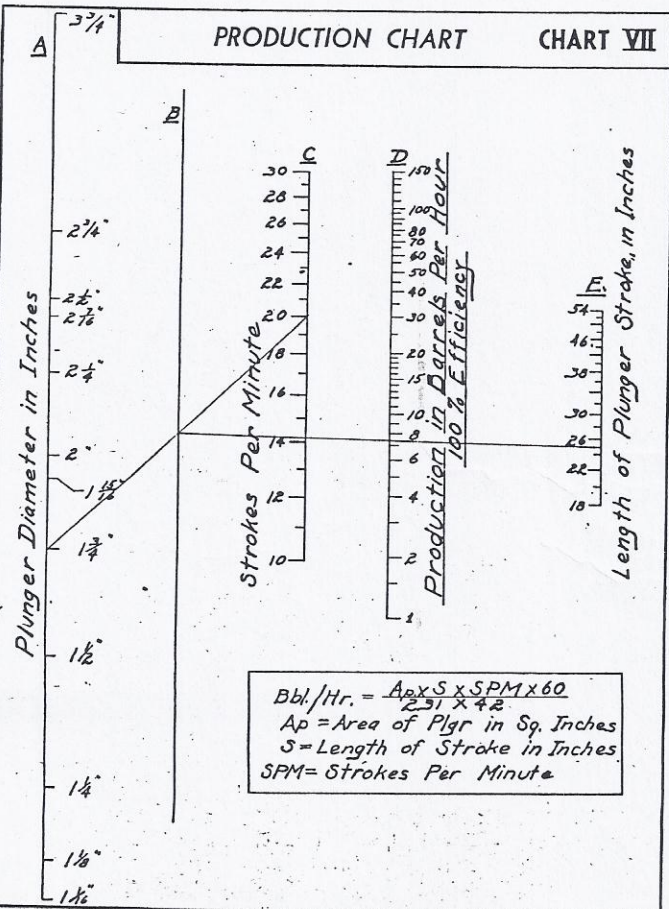
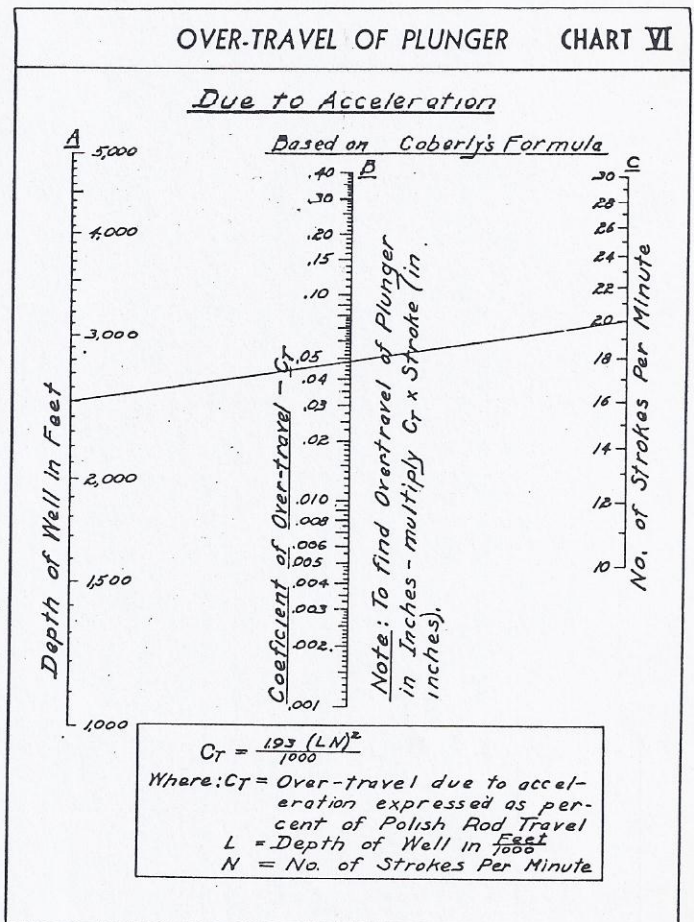
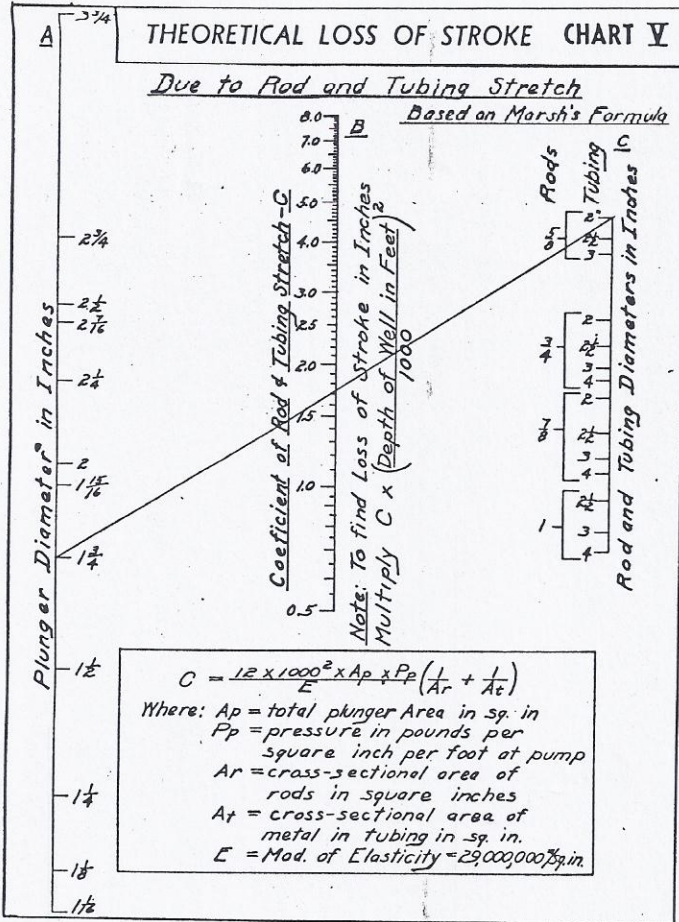

# ALTEN'S FOUNDRY & MACHINE WORKS, LANCASTER, OHIO

## ALTEN UNDERPULL PUMPING JACK

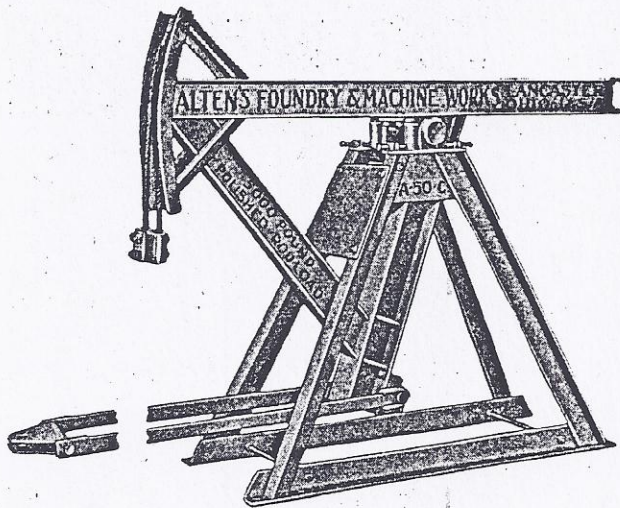

Fig. C-315

These Jacks are heavily designed for long life service and are of the underpull type which reduces the number of pivot points thereby giving better efficiency in counter-balancing. The frame is made in two halves for greater ease in handling but when assembled on foundation gives a rigid assembly. The beam is also assembled in one unit with provisions for bolting on the various parts such as saddle and Pull Bar. The construction permits these jacks to be easily assembled on the foundation and at the same time obtain a perfect alignment over well. The pull rod bars are made of flat steel with equalizing bar for connecting to pull rod lines.

### CONSTRUCTION

The entire jack is fabricated from structural steel by electric welding. This method of fabricating gives greater strength and rigidity with no bolted joints to loosen, throwing the jack out of alignment and eventually causing its destruction. The top of frame is constructed so saddle bearings can be moved forward or backward enabling the operator to align the head over center of well. The polish rod grip and hanger is splattered to a 3/4" Extra flexible mild plow steel rope. Machined hole through polished rod grip is provided to insure perfect grip on polished rod.

### VARIABLE STROKE

The design of the A-50-C Jacks is made to obtain a variable stroke. Considerable range of strokes are obtained by moving the pull bar bearing box vertically on the vertical member of the beam. An approximate straight line motion of polished rod is obtained through the use of the wire line head.

### BEARINGS

Both the Saddle and Pull Bar Bearings are Cast Iron and large oil reservoirs are provided in bearings. Seals are assembled in bearings to retain the oil.

### SPECIFICATIONS FOR ALTEN A-50-C UNDERPULL PUMPING JACK

Rated Polished Rod Load.....	5,000 lbs.
Maximum Stroke.....	32 Inches
Maximum Ratio Polished Rod to Pull Rod Stroke....	1.75:1
Minimum Ratio Polished Rod to Pull Rod Stroke....	1.00:1
Center Saddle to Center of Well.....	45 Inches
Overall Length of Beam.....	7 ft. 6 in.
Depth of Beam.....	6 Inches
Size of Beam.....	6" x 6" — 15 1/2 lbs. B.S.
Top of Foundation to Center of Saddle Bearing...	54 Inches
Top of Foundation to Lower End of Hanger at Mid-Stroke.....	35 Inches
Overall Length of Base.....	72 Inches
Overall Width of Base.....	25 Inches
Number and Size of Foundation Bolts.....	8 — 3/4" x 14"

### Saddle Bearing:

Cast Iron Bearings  
Victor Oil Seal Equipped  
3" Diameter Trunion  
Area of Projected Saddle Bearing.....21 Sq. In.  
Oil Reservoir for Heavy Oil

### Lower Bearing — Pull Bar Connection:

Cast Iron Bearings  
Equipped with Victor Oil Seals  
2" Diameter Trunion  
Projected Bearing Area.....14 Sq. In.  
Oil Reservoir for Heavy Oil

## OKLAHOMA PUMPING JACK

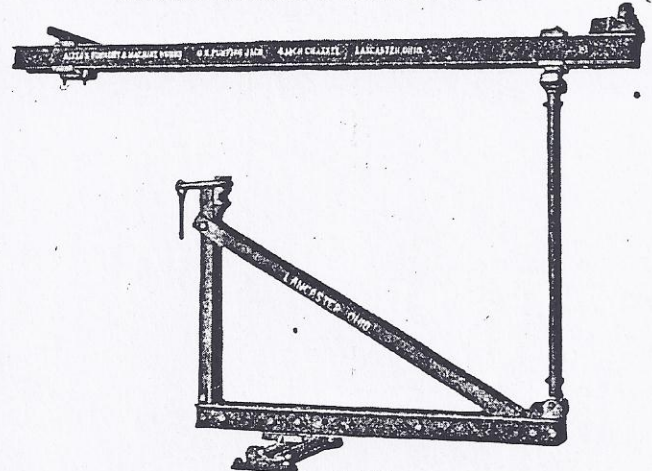

Fig. C-300

Number Jack	Size Beam	Weight Pounds	List Price Complete
2	3"	450	\$48.00
2	4"	490	51.50
3	4"	560	55.50
3	5"	575	56.75
3	6"	590	59.25
4	5"	730	76.00
4	6"	750	78.50

### PUMPING JACK ASSEMBLED PARTS

Part	Weight Pounds	List Price
No. 2 V Assembly only with Saddle.....	225	\$25.75
No. 3 V Assembly only with Saddle.....	274	31.50
No. 4 V Assembly only with Saddle.....	380	37.00
3 Inch Beam Assembly.....	143	13.50
4 Inch Beam Assembly.....	170	16.50
5 Inch Beam Assembly.....	185	19.00
6 Inch x 9 ft. Beam Assembly.....	215	21.50
Pitman complete for No. 2 Jack.....	34	4.50
Pitman complete for No. 3 Jack.....	34	4.50
Pitman complete for No. 4 Jack.....	49	6.25

## ALTEN ROLLER BEARING "D" STIRRUP BOX

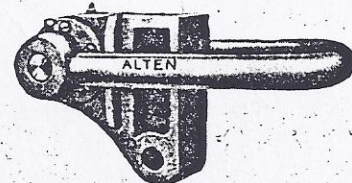

Fig. C-301

This "D" Stirrup Box is interchangeable with other make Jacks. Designed for extremely severe conditions where Common Boxes fail in a short time. Provided with Alemite Fittings so as to give Bearings proper lubrication.

Weight, Pounds..... 58  
Price, Each..... \$25.00

# A ALTEN FOUNDRY & MACHINE WORKS, INC.

## ALTEN'S SERVICE POLICY

Alten Foundry & Machine Works, Inc., recognizes the importance of service in the oil fields. For that reason, Alten maintains a complete staff of sales-service engineers in every major oil-producing center in the United States.

Alten's line of deep- and shallow-well pumping units are sold through your favorite independent supply stores. Spare parts are always available, practically on location.

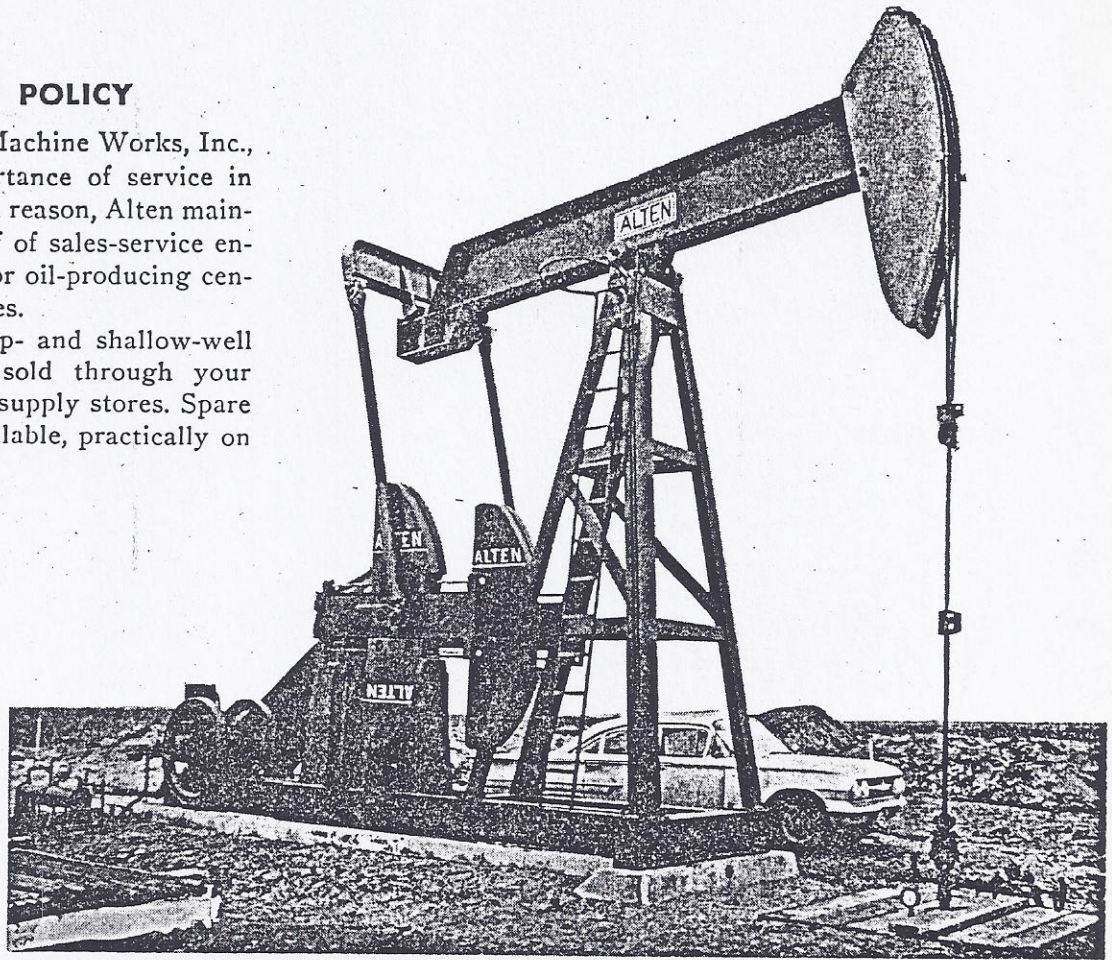

## SALES AND ENGINEERING OFFICES

Odessa, Texas  
 Dallas, Texas  
 Wichita Falls, Texas  
 Shreveport, Louisiana  
 Lancaster, Ohio

Oklahoma City, Oklahoma  
 Tulsa, Oklahoma  
 Calgary, Alberta, Canada  
 Edmonton, Alberta, Canada  
 Estevan, Saskatchewan,  
 Canada

Export Office—New York, N. Y.

## SHIPPING CENTERS

Odessa, Texas..... Phone EMerson 6-5671  
 Oklahoma City, Oklahoma..... Phone ORange 7-5065  
 Lancaster 18, Ohio..... Phone OLive 3-1131

General Offices and Factories  
 Lancaster, Ohio, Phone OL 3-1131

*1-614-653-8624*

Specifications	320-256CF-100	320-246CF-86	228-246CF-86	228-200CF-74
A.P.I. Reducer Size.....	320	320	228	228
Polish Rod Load Rating, lbs.....	25,600	24,600	24,600	20,000
Reducer Torque Rating, in. lbs.....	320,000	320,000	228,000	228,000
Walking Beam Section, in. and lbs.....	27 @ 145	24 @ 120	24 @ 120	24 @ 94
Well Working Section, in.....	129	111	111	96
Well Servicing Clearance, in.....	40	35	35	30
Stroke Lengths, in.....	76, 88, 100	66, 76, 86	66, 76, 86	54, 64, 74
Base Beam Section, in. and lbs.....	14 @ 30	14 @ 30	14 @ 30	14 @ 30
Overall Length of Main Base and Engine Base, ft.-in.....	27-8½	27-8½	27-8½	27-8
Overall Width of Base, ft.-in.....	6-0	6-0	6-0	6-0
Wrist Pin Bearings.....			Self-Aligning Roller.....	
Saddle & Equalizer Bearings.....			Bronze Bushing.....	
Type Gearing.....			Herringbone.....	
Gear Reduction.....				
V-Belt Sheave, Std.....	30:1	30:1	30:1:1	30:1:1
V-Belt Sheave, Max.....	32-6C	36-6C	24-6C	24-6C
Brake (Automotive Type), in.....	14 x 2	14 x 2	32-6C	32-6C
Maximum Counterbalance at Max. Stroke, lbs.....	21,750	20,800	14 x 2	14 x 2
Approx. Wt. with Standard Weights, lbs.....	31,500	29,300	20,800	19,035
			28,100	22,050





# ALTEN FOUNDRY & MACHINE WORKS, INC.

Specifications	160-200CF-74	160-169CF-64	114-169CF-64	114-133CF-54
A.P.I. Reducer Size	160	160	114	114
Polish Rod Load Rating, lbs.	20,000	16,900	16,900	13,300
Reducer Torque Rating, in. lbs.	160,000	160,000	114,000	114,000
Walking Beam Section, in. and lbs.	24 @ 94	21 @ 73	21 @ 73	18 @ 60
Well Working Center, in.	96	81	81	72
Well Servicing Clearance, in.	30	25	25	22
Stroke Lengths, in.	54, 64, 74	44, 54, 64	44, 54, 64	34, 44, 54
Base Beam Section, in. and lbs.	14 @ 30	12 @ 27	12 @ 27	10 @ 21
Overall Length of Main Base and Engine Base, ft.-in.	23-8	20-4½	20-4½	18-0
Overall Width of Base, ft.-in.	6-0	5-9	5-9	4-8
Wrist Pin Bearings			Self-Aligning Roller	
Saddle & Equalizer Bearings			Bronze Bushing	
Type Gearing			Herringbone	
Gear Reduction	30.2:1	30.2:1	30.9:1	30.9:1
V-Belt Sheave, Std.	24-5C	24-5C	24-4C	20-4C
V-Belt Sheave, Max.	32-5C	32-5C	26-4C	26-4C
Brake (Automotive Type), in.	14 x 2	14 x 2	9 x 1¾	9 x 1¾
Maximum Counterbalance at Max. Stroke, lbs.	19,085	15,340	15,340	11,300
Approx. Wt. with Standard Weights, lbs.	21,350	19,050	16,200	14,750

Specifications	114-119CF-54	80-133CF-54	80-119CF-54	80-109CF-48
A.P.I. Reducer Size	114	80	80	80
Polish Rod Load Rating, lbs.	11,900	13,300	11,900	10,900
Reducer Torque Rating, in. lbs.	114,000	80,000	80,000	80,000
Walking Beam Section, in. and lbs.	18 @ 55	18 @ 60	18 @ 55	14 @ 48
Well Working Center, in.	72	72	72	65
Well Servicing Clearance, in.	22	22	22	25½
Stroke Lengths, in.	34, 44, 54	34, 44, 54	34, 44, 54	25, 37, 48
Base Beam Section, in. and lbs.	10 @ 21	10 @ 21	10 @ 21	8 @ 17
Overall Length of Main Base and Engine Base, ft.-in.	18-0	18-0	18-0	16-4
Overall Width of Base, ft.-in.	4-8	4-8	4-8	3-2½
Wrist Pin Bearings			Self-Aligning Roller	
Saddle & Equalizer Bearings			Bronze Bushing	
Type Gearing			Herringbone	
Gear Reduction	30.9:1	30.5:1	30.5:1	30.5:1
V-Belt Sheave, Std.	20-4C	20-3C	20-3C	20-3C
V-Belt Sheave, Max.	26-4C	24-3C	24-3C	24-3C
Brake (Automotive Type), in.	9 x 1¾	9 x 1¾	9 x 1¾	9 x 1¾
Maximum Counterbalance at Max. Stroke, lbs.	11,300	11,300	11,300	8,910
Approx. Wt. with Standard Weights, lbs.	13,070	14,180	12,500	10,800

## CONSTRUCTION FEATURES

- **Gear Reducer.** Patented rigid one-piece housing; A.P.I. gears and pinions; Anti-friction bearings throughout; positive lubrication
- **Exclusive Magnetic Oil Cleaner**  
Oil in reducer is cleaned of foreign particles by magnetic cleaner and sump; lengthens gear and bearing life
- **Automotive Brake**  
Truck-type brake; provides positive safety for personnel
- **Screw-Type Adjustable Counterbalance**  
Safest and simplest Counterbalance made; "easiest to use" say pumpers everywhere
- **Bronze Saddle & Equalizer Bearings**  
Oversized uncomplicated bronze bearings; four-way adjustment of saddle
- **Step-Down Equalizer**  
No bolts in tension; solid rolled steel construction
- **Adjustable Hinged Horsehead**  
Swings back for well servicing; adjustable for precise alignment
- **Adjustable Polished Rod Hanger**  
Easily adjusted or replaced in field; no babbitted connections
- **Tapered Wrist Pins**  
Unique pin-lock design simplifies wrist pin changes; Oversized self-aligning bearings
- **Rugged Frame & Samson Post**  
Jig-welded for precision; braced for rigidity; over-engineered for brute strength; all-welded ladder with safety ring standard on larger sizes
- **Easy Installation**  
Frames designed for both center-tie-down or foundation-bolt assembly
- **Portable Skid Base**  
Rugged, all-welded skid base; permits unit to be changed to or from portable type by just adding or removing the skid base
- **Shorty Type Base (Optional)**  
Sturdy motor base; permits the use of shorter foundation

# A ALTEN FOUNDRY & MACHINE WORKS, INC.

Specifications	80-109CF-42	80-95CF-48	57-109CF-48	57-109CF-42
A.P.I. Reducer Size	80	80	57	57
Polish Rod Load Rating, lbs.	10,900	9,500	10,900	10,900
Reducer Torque Rating, in. lbs.	80,000	80,000	57,000	57,000
Walking Beam Section, in. and lbs.	14 @ 43	14 @ 43	14 @ 48	14 @ 43
Well Working Center, in.	57	65	65	57
Well Servicing Clearance, in.	17 1/2	25 1/2	25 1/2	17 1/2
Stroke Lengths, in.	22, 32, 42	25, 37, 48	25, 37, 48	22, 32, 42
Base Beam Section, in. and lbs.	8 @ 17	8 @ 17	8 @ 17	8 @ 17
Overall Length of Main Base and Engine Base, ft.-in.	16-4	16-4	16-4	16-4
Overall Width of Base, ft.-in.	3-2 1/2	3-2 1/2	3-2 1/2	3-2 1/2
Wrist Pin Bearings	Self-Aligning Roller			
Saddle & Equalizer Bearings	Bronze Bushing			
Type Gearing	Herringbone			
Gear Reduction	30.5:1	30.5:1	30.9:1	30.9:1
V-Belt Sheave, Std.	20-3C	20-3C	19-3C	19-3C
V-Belt Sheave, Max.	24-3C	24-3C	24-3C	24-3C
Brake (Automotive Type), In.	9 x 1 1/4	9 x 1 1/4	9 x 1 1/4	9 x 1 1/4
Maximum Counterbalance at Max. Stroke, lbs.	10,185	8,910	8,910	10,185
Approx. Wt. with Standard Weights, lbs.	10,645	10,700	10,120	9,965

Specifications	57-95CF-48	40-89CF-42	40-89CF-36	40-76CF-42
A.P.I. Reducer Size	57	40	40	40
Polish Rod Load Rating, lbs.	9,500	8,900	8,900	7,600
Reducer Torque Rating, in. lbs.	57,000	40,000	4,000	40,000
Walking Beam Section, in. and lbs.	14 @ 43	14 @ 34	12 @ 36	12 @ 36
Well Working Center, in.	65	56	46	56
Well Servicing Clearance, in.	25 1/2	11	10	18
Stroke Lengths, in.	25, 37, 48	24, 33, 42	21, 28, 36	24, 33, 42
Base Beam Section, in. and lbs.	8 @ 17	8 @ 11.5	8 @ 11.5	8 @ 11.5
Overall Length of Main Base and Engine Base, ft.-in.	16-4	13-3	13-3	13-3
Overall Width of Base, ft.-in.	3-2 1/2	3-2 1/2	3-2 1/2	3-2 1/2
Wrist Pin Bearings	Self-Aligning Roller			
Saddle & Equalizer Bearings	Bronze Bushing			
Type Gearing	Herringbone	Helical	Helical	Helical
Gear Reduction	30.9:1	28.4:1	28.4:1	28.4:1
V-Belt Sheave, Std.	19-3C	16.75-4B	16.75-4B	16.75-4B
V-Belt Sheave, Max.	24-3C	9 x 1 1/4		9 x 1 1/4
Brake (Automotive Type), in.	9 x 1 1/4	6,950	8,100	6,950
Maximum Counterbalance at Max. Stroke, lbs.	8,910	7,120	7,020	7,050
Approx. Wt. with Standard Weights, lbs.	10,020			

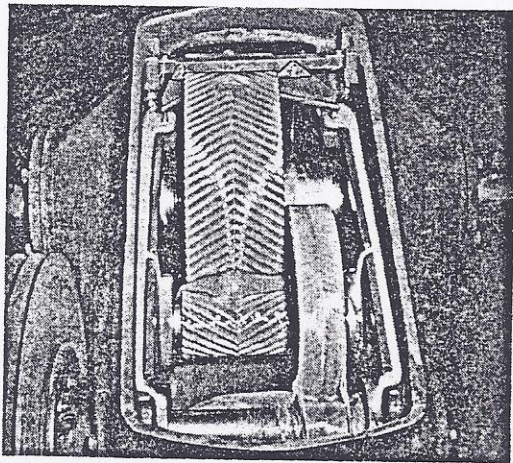

## OUTSTANDING FEATURES OF ALTEN SPEED REDUCERS



Precision-machined, heat-treated herringbone gears and pinions are manufactured to A.P.I. specifications. Continuous-tooth herringbone design eliminates side thrusts, provides reserve strength with its arch-like construction, plus very low tooth deflection due to the large number of teeth in contact.

Self-adjusting wipers give positive lubrication to all bearings regardless of direction of rotation.

Exclusive magnetic oil cleaner and sump removes foreign matter from the circulating oil, providing clean oil to bearings at all times, thus increasing the life of the reducer.

Sturdy, one-piece housing of high-tensile gray iron, designed for maximum strength and rigidity . . . Rib-reinforced . . . Patented design eliminates condensation problems . . . Assures long life with perfect gear alignment.

Bearings. All shafts are equipped with anti-friction bearings. Heavy-duty roller-type bearings have reserve strength capacity to withstand severe impact loads without damage.

## EASIEST AND SAFEST TO COUNTERBALANCE

New type adjustable counterbalance incorporates numerous features not found in any other type. Although rugged enough to meet the most strenuous conditions, it is so amazingly simple that counterbalance weights may be adjusted with wrench we furnish in a matter of minutes by one man standing on the ground. Screw arrangement gives your operator full control at all times and prevents the weights from falling or sliding and positively holds weights in any position at any time. Alten's adjustable counterbalance assures your operator the safest possible working conditions. Calibrations make it easy to locate weights for desired counterbalance. Interchangeable weights of various sizes are offered for all units making necessary only the purchase of such amount of counterbalance essential to each well condition.

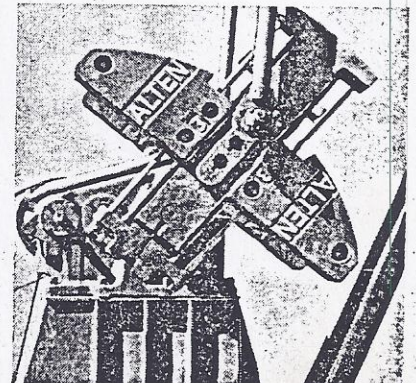

(Continued on Next Page)



# BEAM-BALANCED UNITS

- Rugged one-piece reducer housing
- Positive oil-bath lubrication
- Floor-clearing cranks

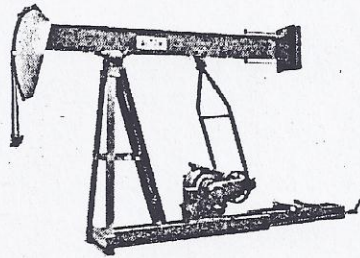

- Rigid one-piece frame and samson post
- Bronze bushed saddle and equalizer bearing
- Sturdy one-piece pitman assembly

Specifications	40-89F-36	40-76F-42	25-67F-30	25-56F-36	16-53F-24	16-43F-30	16-40F-20	16-27F-30
A.P.I. Reducer Size.....	40	40	25	25	16	16	16	16
Polish Rod Load Rating, lbs.....	8900	7600	6700	5600	5300	4300	4000	2700
Reducer Torque Rating, in. lbs.....	40,000	40,000	25,000	25,000	16,000	16,000	16,000	16,000
Walking Beam Section, in. and lbs.....	12 @ 36	12 @ 36	10 @ 25	10 @ 25	8 @ 20	8 @ 20	8 @ 15	8 @ 15
Well Working Center, in.....	48	56	39	47	32	40	26	39
Well Servicing Clearance, in.....	10	18	12	20	7	15	6½	12
Stroke Lengths, in.....	29, 32, 36	34, 37, 42	23, 26, 30	27, 31, 36	20, 22, 24	24, 27, 30	16, 18, 20	24, 27, 30
Base Beam Section, in. and lbs.....	8 @ 11.5	8 @ 11.5	6 @ 8.2	6 @ 8.2	5 @ 6.7	5 @ 6.7	5 @ 6.7	5 @ 6.7
Overall Length of Base, ft.-in.....	13-3	13-3	9-10	9-10	8-4	8-4	8-4	8-2
Overall Width of Base, ft.-in.....	3-2½	3-2½	2-9	2-9	2-2	2-2	2-2	2-4
Wrist Pin Bearings.....					Self-Aligning Roller			
Saddle & Equalizer Bearings.....					Bronze Bushed			
Type Gearing.....					Helical			
Gear Reduction.....	28.4:1	28.4:1	28.4:1	28.4:1	33.2:1	33.2:1	33.2:1	33.2:1
V-Belt Sheave, Std.....	16.75-4B	16.75-4B	16.125-3B	16.125-3B	12.6-2B	12.6-2B	12.6-2B	12.6-2B
V-Belt Sheave, Max.....					15.9-2B	15.9-2B	15.9-2B	15.9-2B
Brake (Automotive Type), in.....	9 x 1¼	9 x 1¼	9 x 1¼	9 x 1¼	9 x 1¼	9 x 1¼	9 x 1¼	9 x 1¼
Max. Counterbalance, lbs.....	7250	6145	5250	4380	4265	3390	3720	2480
Approx. Wt., Less Beam Weights, lbs.....	3075	3110	1970	2000	1090	1120	850	880

Specifications	10-32F-16	10-21F-24	6-32F-16	6-21F-24	6-20F-16	6-15F-24	4-15F-12
A.P.I. Reducer Size.....	10	10	6.4	6.4	6.4	6.4	.....
Polish Rod Load Rating, lbs.....	3200	2100	3200	2100	2000	1500	1500
Reducer Torque Rating, in. lbs.....	10,000	10,000	6,400	6,400	6,400	6,400	4,600
Walking Beam Section, in. and lbs.....	8 @ 13	8 @ 13	8 @ 13	8 @ 13	6 @ 12	6 @ 12	6 @ 12
Well Working Center, in.....	22	33	22	33	22	33	18
Well Servicing Clearance, in.....	6½	9	6½	9	6½	9	5½
Stroke Lengths, in.....	14, 16	21, 24	14, 16	21, 24	14, 16	21, 24	12
Base Beam Section, in. and lbs.....	4 @ 5.4	4 @ 5.4	4 @ 5.4	4 @ 5.4	4 @ 5.4	4 @ 5.4	4 @ 5.4
Overall Length of Base, ft.-in.....	6-1	6-1	6-1	6-1	5-6½	5-6½	5-0
Overall Width of Base, ft.-in.....	1-6	1-6	1-6	1-6	1-6	1-6	1-6
Wrist Pin Bearings.....					Self-Aligning Roller		Bushing
Saddle & Equalizer Bearings.....					Bronze Bushed		
Type Gearing.....					Helical		
Gear Reduction.....	30.24:1	30.24:1	30.24:1	30.24:1	30.24:1	30.24:1	30.24:1
V-Belt Sheave.....	12-2AB	12-2AB	12-1AB	12-1AB	12-1AB	12-1AB	12-1AB
Brake (Automotive Type), in.....	Optional	Optional	Optional	Optional	Optional	Optional	.....
Max. Counterbalance, lbs.....	2470	1850	2470	1850	1890	1475	1390
Approx. Wt., Less Beam Weights, lbs.....	670	690	650	670	550	560	325

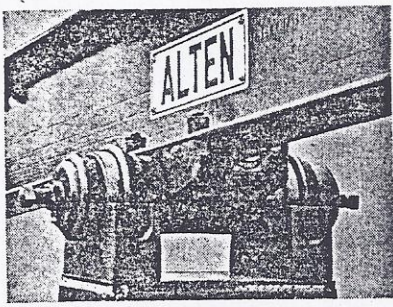

## STRONGEST IN THE SADDLE

The Alten pumping unit's bronze-bushed saddle bearing is really three sturdy bearings in one. Since only the bottom of the bearing wears, a 120-degree rotation gives you an entirely new bearing surface. You get 200% longer bearing life. And the bronze bearing withstands shock loads best.

- The rugged simplicity of the Alten saddle provides trouble-free operation with an absolute minimum of parts. It is "oversize" to stand up under the heaviest use and worst abuse.
- The Alten saddle also permits easy adjustment of the walking beam to and from the well for centering the polished rod hanger. And it allows convenient lateral adjustment of the walking beam.

## MOST PRACTICAL HORSEHEAD

The horsehead of an Alten unit makes servicing your well faster and easier. Remove one bolt and the horsehead swings back over the beam. Or remove the horsehead completely. • Perfect alignment with the well is made possible by means of a radiused support between horsehead and beam. Simple adjusting screws make and maintain alignment. • Full side plates designed for maximum safety of your operator.

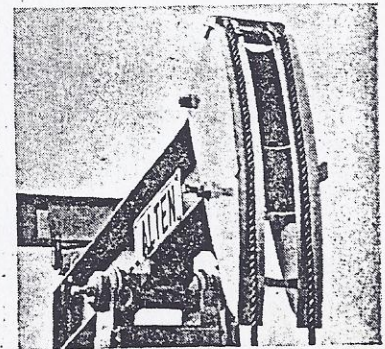



# ALTEN FOUNDRY & MACHINE WORKS, INC.

## ALTEN'S SERVICE POLICY

Alten Foundry & Machine Works, Inc., recognizes the importance of service in the oil fields. For that reason, Alten maintains a complete staff of sales-service engineers in every major oil-producing center in the United States.

Alten's line of deep- and shallow-well pumping units are sold through your favorite independent supply stores. Spare parts are always available, practically on location.

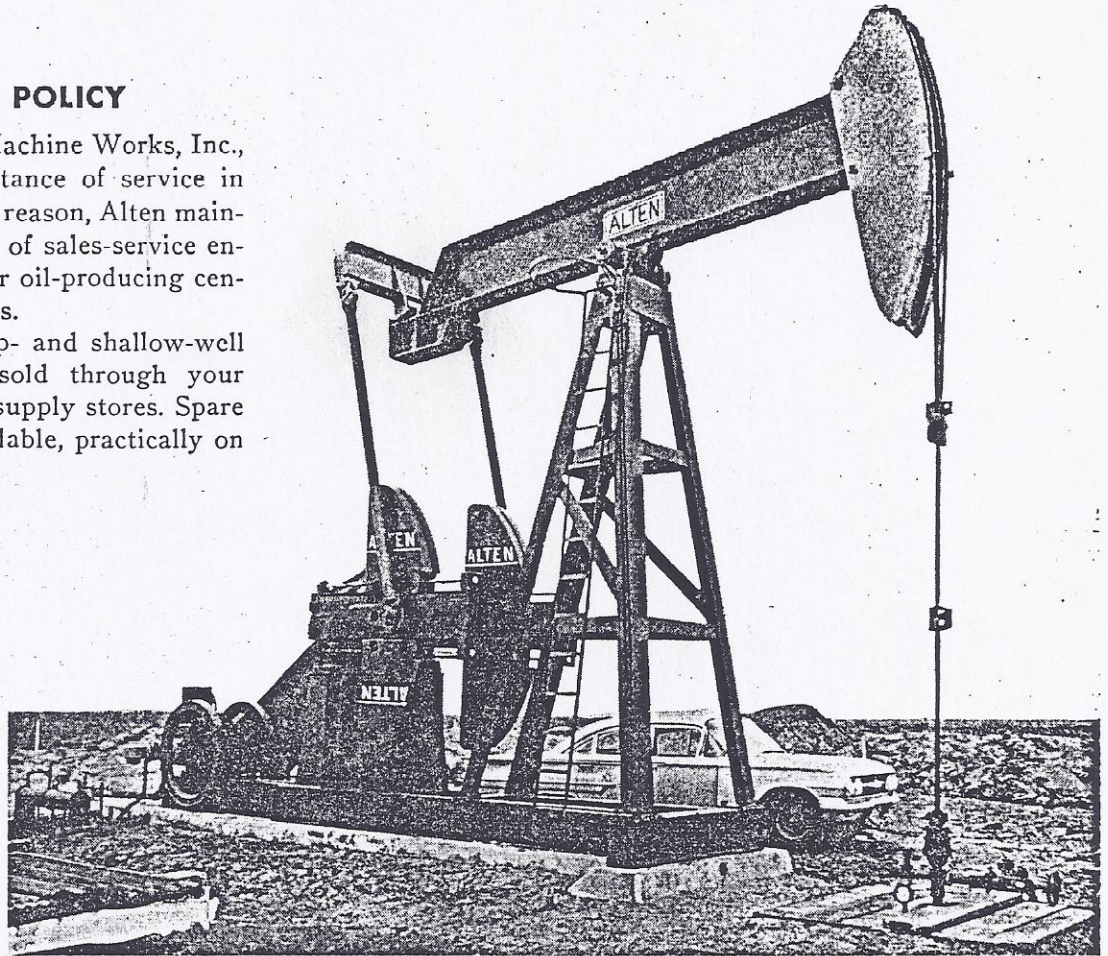

## SALES AND ENGINEERING OFFICES

Odessa, Texas  
Dallas, Texas  
Wichita Falls, Texas  
Shreveport, Louisiana  
Lancaster, Ohio  
Grayville, Illinois

Oklahoma City, Oklahoma  
Tulsa, Oklahoma  
Marlow, Oklahoma  
Wichita, Kansas  
Los Angeles, California  
Calgary, Alberta, Canada

Export Office—New York, N. Y.  
Phone MURRAY Hill 5-0658

## SHIPPING CENTERS

Odessa, Texas..... Phone EMerson 6-5671  
Oklahoma City, Oklahoma..... Phone ORange 7-5065  
Lancaster 18, Ohio..... Phone OLive 3-1131

General Offices and Factories  
Lancaster, Ohio, Phone OL 3-1131

Specifications	320-256CF-100	320-246CF-86	228-246CF-86	228-200CF-74
A.P.I. Reducer Size.....	320	320	228	228
Polish Rod Load Rating, lbs.....	25,600	24,600	24,600	20,000
Reducer Torque Rating, in. lbs.....	320,000	320,000	228,000	228,000
Walking Beam Section, in. and lbs.....	24 @ 130	24 @ 120	24 @ 120	24 @ 94
Well Working Center, in.....	130	112	112	96
Well Servicing Clearance, in.....	30	24	24	22
Stroke Lengths, in.....	76, 88, 100	66, 76, 86	66, 76, 86	54, 64, 74
Base Beam Section, in. and lbs.....	14 @ 30	14 @ 30	14 @ 30	12 @ 27
Overall Length of Main Base and Engine Base, ft.-in.....	26-0	26-0	26-0	23-0
Overall Width of Base, ft.-in.....	5-8	5-8	5-8	5-4
Wrist Pin Bearings.....			Self-Aligning Roller.....	
Saddle & Equalizer Bearings.....			Bronze Bushing.....	
Type Gearing.....			Herringbone.....	
Gear Reduction.....	30:1	30:1	32:1:1	32:1:1
V-Belt Sheave, Std.....	32-8C	32-8C	24-6C	24-6C
V-Belt Sheave, Max.....			32-6C	32-6C
Brake (Automotive Type), in.....	14 x 2	14 x 2	14 x 2	14 x 2
Maximum Counterbalance at Max. Stroke, lbs.....	21,750	20,800	20,800	19,085
Approx. Wt. with Standard Weights, lbs.....	31,500	29,300	28,100	22,050

(Continued on Next Page)



# ALTEN FOUNDRY & MACHINE WORKS, INC.

Specifications	160-200CF-74	160-169CF-64	114-169CF-64	114-133CF-54
A.P.I. Reducer Size	160	160	114	114
Polish Rod Load Rating, lbs.	20,000	16,900	16,900	13,300
Reducer Torque Rating, in. lbs.	160,000	160,000	114,000	114,000
Walking Beam Section, in. and lbs.	24 @ 94	21 @ 73	21 @ 73	18 @ 60
Well Working Center, in.	96	83	83	70
Well Servicing Clearance, in.	22	18	18	18
Stroke Lengths, in.	54, 64, 74	44, 54, 64	44, 54, 64	34, 44, 54
Base Beam Section, in. and lbs.	12 @ 27	12 @ 27	12 @ 27	10 @ 21
Overall Length of Main Base and Engine Base, ft.-in.	23-0	21-9	21-9	18-6
Overall Width of Base, ft.-in.	5-4	5-0	5-0	4-2
Wrist Pin Bearings			Self-Aligning Roller	
Saddle & Equalizer Bearings			Bronze Bushing	
Type Gearing			Herringbone	
Gear Reduction	30.2:1	30.2:1	30.9:1	30.9:1
V-Belt Sheave, Std.	24-5C	24-5C	20-4C	20-4C
V-Belt Sheave, Max.	32-5C	32-5C	26-4C	26-4C
Brake (Automotive Type), in.	14 x 2	14 x 2	9 x 1 3/4	9 x 1 3/4
Maximum Counterbalance at Max. Stroke, lbs.	19,085	15,340	11,300	11,300
Approx. Wt. with Standard Weights, lbs.	21,350	19,050	16,200	14,750

Specifications	114-119CF-54	80-133CF-54	80-119CF-54	80-109CF-48
A.P.I. Reducer Size	114	80	80	80
Polish Rod Load Rating, lbs.	11,900	13,300	11,900	10,900
Reducer Torque Rating, in. lbs.	114,000	80,000	80,000	80,000
Walking Beam Section, in. and lbs.	18 @ 50	18 @ 60	18 @ 50	16 @ 45
Well Working Center, in.	70	70	70	61.75
Well Servicing Clearance, in.	18	18	18	14
Stroke Lengths, in.	34, 44, 54	34, 44, 54	34, 44, 54	28, 38, 48
Base Beam Section, in. and lbs.	10 @ 21	10 @ 21	10 @ 21	8 @ 17
Overall Length of Main Base and Engine Base, ft.-in.	18-6	18-6	18-6	14-8
Overall Width of Base, ft.-in.	4-2	4-2	4-2	3-9
Wrist Pin Bearings			Self-Aligning Roller	
Saddle & Equalizer Bearings			Bronze Bushing	
Type Gearing			Herringbone	
Gear Reduction	30.9:1	30.5:1	30.5:1	30.5:1
V-Belt Sheave, Std.	20-4C	19-3C	19-3C	19-3C
V-Belt Sheave, Max.	26-4C	24-3C	24-3C	24-3C
Brake (Automotive Type), in.	9 x 1 3/4	9 x 1 3/4	9 x 1 3/4	9 x 1 3/4
Maximum Counterbalance at Max. Stroke, lbs.	11,300	11,300	11,300	8,910
Approx. Wt. with Standard Weights, lbs.	13,070	14,180	12,500	10,800

## CONSTRUCTION FEATURES

- Gear Reducer. Patented rigid one-piece housing; A.P.I. gears and pinions; Anti-friction bearings throughout; positive lubrication
- Exclusive Magnetic Oil Cleaner  
Oil in reducer is cleaned of foreign particles by magnetic cleaner and sump; lengthens gear and bearing life
- Automotive Brake  
Truck-type brake; provides positive safety for personnel
- Screw-Type Adjustable Counterbalance  
Safest and simplest Counterbalance made; "easiest to use" say pumpers everywhere
- Bronze Saddle & Equalizer Bearings  
Oversized uncomplicated bronze bearings; four-way adjustment of saddle
- Step-Down Equalizer  
No bolts in tension; solid rolled steel construction
- Adjustable Hinged Horsehead  
Swings back for well servicing; adjustable for precise alignment
- Adjustable Polished Rod Hanger  
Easily adjusted or replaced in field; no babbitted connections
- Tapered Wrist Pins  
Unique pin-lock design simplifies wrist pin changes; Oversized self-aligning bearings
- Rugged Frame & Samson Post  
Jig-welded for precision; braced for rigidity; over-engineered for brute strength; all-welded ladder with safety ring standard on larger sizes
- Easy Installation  
Frames designed for both center-tie-down or foundation-bolt assembly
- Portable Skid Base  
Rugged, all-welded skid base; permits unit to be changed to or from portable type by just adding or removing the skid base
- Shorty Type Base (Optional)  
Sturdy motor base; permits the use of shorter foundation



# ALTEN FOUNDRY & MACHINE WORKS, INC.

Specifications	80-109CF-42	80-95CF-48	57-109CF-48	57-109CF-42
A.P.I. Reducer Size.....	80	80	57	57
Polish Rod Load Rating, lbs.....	10,900	9,500	10,900	10,900
Reducer Torque Rating, in. lbs.....	80,000	80,000	57,000	57,000
Walking Beam Section, in. and lbs.....	14 @ 43	14 @ 43	16 @ 45	14 @ 43
Well Working Center, in.....	54	61.75	61.75	54
Well Servicing Clearance, in.....	12	18	14	12
Stroke Lengths, in.....	24, 33, 42	28, 38, 48	28, 38, 48	24, 33, 42
Base Beam Section, in. and lbs.....	8 @ 17	8 @ 17	8 @ 17	8 @ 17
Overall Length of Main Base and Engine Base, ft.-in.....	14-8	14-8	14-8	14-8
Overall Width of Base, ft.-in.....	3-9	3-9	3-9	3-9
Wrist Pin Bearings.....			Self-Aligning Roller.....	
Saddle & Equalizer Bearings.....			Bronze Bushing.....	
Type Gearing.....			Herringbone.....	
Gear Reduction.....	30.5:1	30.5:1	30.9:1	30.9:1
V-Belt Sheave, Std.....	19-3C	19-3C	19-3C	19-3C
V-Belt Sheave, Max.....	24-3C	24-3C	24-3C	24-3C
Brake (Automotive Type), in.....	9 x 1 1/4	9 x 1 1/4	9 x 1 1/4	9 x 1 1/4
Maximum Counterbalance at Max. Stroke, lbs.....	10,185	8,910	8,910	10,185
Approx. Wt. with Standard Weights, lbs.....	10,645	10,700	10,120	9,965

Specifications	57-95CF-48	40-89CF-42	40-89CF-36	40-76CF-42
A.P.I. Reducer Size.....	57	40	40	40
Polish Rod Load Rating, lbs.....	9,500	8,900	8,900	7,600
Reducer Torque Rating, in. lbs.....	57,000	40,000	4,000	40,000
Walking Beam Section, in. and lbs.....	14 @ 43	14 @ 34	12 @ 36	12 @ 36
Well Working Center, in.....	61.75	54	46	54
Well Servicing Clearance, in.....	18	11	10	18
Stroke Lengths, in.....	28, 38, 48	28, 35, 42	24, 30, 36	28, 35, 42
Base Beam Section, in. and lbs.....	8 @ 17	8 @ 13	8 @ 13	8 @ 13
Overall Length of Main Base and Engine Base, ft.-in.....	14-8	13-0	13-0	13-0
Overall Width of Base, ft.-in.....	3-9	3-3	3-3	3-3
Wrist Pin Bearings.....			Self-Aligning Roller.....	
Saddle & Equalizer Bearings.....			Bronze Bushing.....	
Type Gearing.....			Herringbone.....	
Gear Reduction.....	30.9:1	Helical 28.4:1	Helical 28.4:1	Helical 28.4:1
V-Belt Sheave, Std.....	19-3C	16.75-4B	16.75-4B	16.75-4B
V-Belt Sheave, Max.....	24-3C			
Brake (Automotive Type), in.....	9 x 1 1/4	9 x 1 1/4	9 x 1 1/4	9 x 1 1/4
Maximum Counterbalance at Max. Stroke, lbs.....	8,910	6,950	8,100	6,950
Approx. Wt. with Standard Weights, lbs.....	10,020	7,120	7,020	7,050

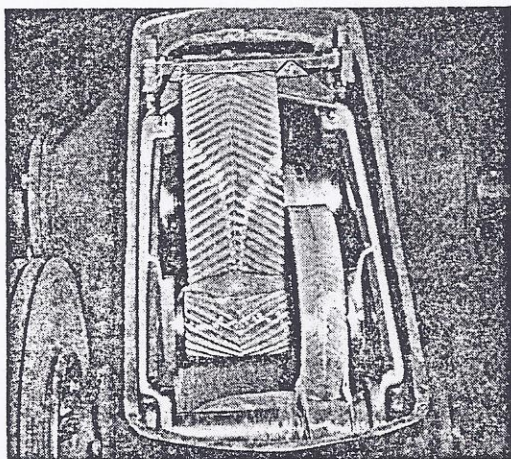

## OUTSTANDING FEATURES OF ALTEN SPEED REDUCERS



Precision-machined, heat-treated herringbone gears and pinions are manufactured to A.P.I. specifications. Continuous-tooth herringbone design eliminates side thrusts, provides reserve strength with its arch-like construction, plus very low tooth deflection due to the large number of teeth in contact.

Self-adjusting wipers give positive lubrication to all bearings regardless of direction of rotation.

Exclusive magnetic oil cleaner and sump removes foreign matter from the circulating oil, providing clean oil to bearings at all times, thus increasing the life of the reducer.

Sturdy, one-piece housing of high-tensile gray iron, designed for maximum strength and rigidity . . . Rib-reinforced . . . Patented design eliminates condensation problems . . . Assures long life with perfect gear alignment.

Bearings. All shafts are equipped with anti-friction bearings. Heavy-duty roller-type bearings have reserve strength capacity to withstand severe impact loads without damage.

## EASIEST AND SAFEST TO COUNTERBALANCE

New type adjustable counterbalance incorporates numerous features not found in any other type. Although rugged enough to meet the most strenuous conditions, it is so amazingly simple that counterbalance weights may be adjusted with wrench we furnish in a matter of minutes by one man standing on the ground. Screw arrangement gives your operator full control at all times and prevents the weights from falling or sliding and positively holds weights in any position at any time. Alten's adjustable counterbalance assures your operator the safest possible working conditions. Calibrations make it easy to locate weights for desired counterbalance. Interchangeable weights of various sizes are offered for all units making necessary only the purchase of such amount of counterbalance essential to each well condition.

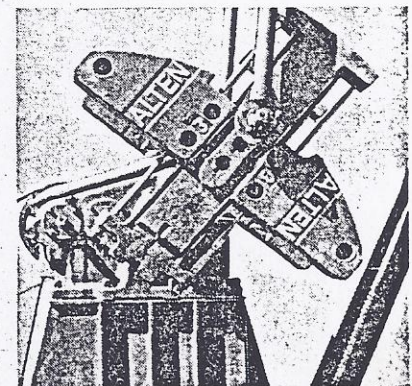

(Continued on Next Page)

A

# BEAM BALANCED UNITS

- Rugged one-piece reducer housing
  - Positive oil-bath lubrication
  - Floor-clearing cranks

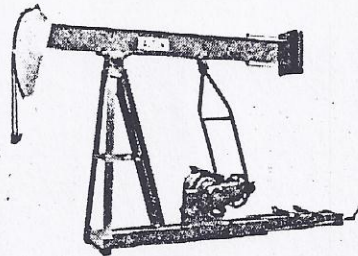

- Rigid one-piece frame and samson post
- Bronze bushed saddle and equalizer bearing
- Sturdy one-piece pitman assembly

Specifications	40-89F-36	40-76F-42	25-67F-30	25-56F-36	16-53F-24	16-43F-30	16-40F-20	16-27F-30
A.P.I. Reducer Size	40	40	25	25	16	16	16	16
Polish Rod Load Rating, Lbs.	8900	7600	6700	5600	5300	4300	4000	2700
Reducer Torque Rating, in. lbs.	40,000	40,000	25,000	25,000	16,000	16,000	16,000	16,000
Walking Beam Section, in. and lbs.	12 @ 36	12 @ 36	10 @ 25	10 @ 25	8 @ 20	8 @ 20	8 @ 15	8 @ 15
Well Working Center, in.	46	54	39	46	32	40	26	39
Well Servicing Clearance, in.	10	18	8	15	7	15	6½	12
Stroke Lengths, in.	30, 33, 36	35, 38½, 42	23, 26, 30	27, 31, 36	20, 22, 24	24, 27, 30	16, 18, 20	24, 27, 30
Base Beam Section, in. and lbs.	8 @ 11.5	8 @ 11.5	6 @ 8.2	6 @ 8.2	5 @ 6.7	5 @ 6.7	5 @ 6.7	5 @ 6.7
Overall Length of Base, ft.-in.	12-4	12-4	9-4	9-4	8-2	8-2	8-2	8-2
Overall Width of Base, ft.-in.	3-3	3-3	2-10	2-10	2-2	2-2	2-2	2-2
Wrist Pin Bearings	Self-Aligning Roller							
Saddle & Equalizer Bearings	Bronze Bushed							
Type Gearing	Helical							
Gear Reduction	28.4:1	28.4:1	28.4:1	28.4:1	33.2:1	33.2:1	33.2:1	33.2:1
V-Belt Sheave, Std.	16.75-4B	16.75-4B	16.125-3B	16.125-3B	12.6-2B	12.6-2B	12.6-2B	12.6-2B
V-Belt Sheave, Max.					15.9-2B	15.9-2B	15.9-2B	15.9-2B
Brake (Automotive Type), in.	9 x 1¾	9 x 1¾	9 x 1¾	9 x 1¾	9 x 1¾	9 x 1¾	9 x 1¾	9 x 1¾
Max. Counterbalance, lbs.	7250	6145	5250	4380	4265	3390	3720	2480
Approx. Wt., Less Beam Weights, lbs.	3075	3110	1970	2000	1090	1120	850	880

Specifications	10-32F-16	10-21F-24	6-32F-16	6-21F-24	6-20F-16	6-15F-24	4-15F-12	
A.P.I. Reducer Size	10	10	6.4	6.4	6.4	6.4	.....	
Polish Rod Load Rating, lbs.	3200	2100	3200	2100	2000	1500	1500	
Reducer Torque Rating, in. lbs.	10,000	10,000	6,400	6,400	6,400	6,400	4,600	
Walking Beam Section, in. and lbs.	8 @ 13	8 @ 13	8 @ 13	8 @ 13	6 @ 12	6 @ 12	6 @ 12	
Well Working Center, in.	22	33	22	33	22	33	18	
Well Servicing Clearance, in.	6½	9	6½	9	6½	9	5½	
Stroke Lengths, in.	14, 16	21, 24	14, 16	21, 24	14, 16	21, 24	12	
Base Beam Section, in. and lbs.	4 @ 5.4	4 @ 5.4	4 @ 5.4	4 @ 5.4	4 @ 5.4	4 @ 5.4	4 @ 5.4	
Overall Length of Base, ft.-in.	6-1	6-1	6-1	6-1	5-6½	5-6½	5-0	
Overall Width of Base, ft.-in.	1-6	1-6	1-6	1-6	1-6	1-6	1-6	
Wrist Pin Bearings	Self-Aligning Roller							Bushing
Saddle & Equalizer Bearings	Bronze Bushed							
Type Gearing	Helical							
Gear Reduction	30.24:1	30.24:1	30.24:1	30.24:1	30.24:1	30.24:1	30.24:1	
V-Belt Sheave	12-2AB	12-2AB	12-1AB	12-1AB	12-1AB	12-1AB	12-1AB	
Brake (Automotive Type), in.	Optional	Optional	Optional	Optional	Optional	Optional	.....	
Max. Counterbalance, lbs.	2470	1850	2470	1850	1890	1475	1390	
Approx. Wt., Less Beam Weights, lbs.	670	690	650	670	550	560	325	

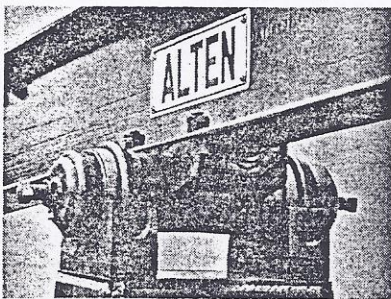

## STRONGEST IN THE SADDLE

The Alten pumping unit's bronze-bushed saddle bearing is really three sturdy bearings in one. Since only the bottom of the bearing wears, a 120-degree rotation gives you an entirely new bearing surface. You get 200% longer bearing life. And the bronze bearing withstands shock loads best.

- The rugged simplicity of the Alten saddle provides trouble-free operation with an absolute minimum of parts. It is "oversize" to stand up under the heaviest use and worst abuse.
- The Alten saddle also permits easy adjustment of the walking beam to and from the well for centering the polished rod hanger. And it allows convenient lateral adjustment of the walking beam.

## MOST PRACTICAL HORSEHEAD

The horsehead of an Alten unit makes servicing your well faster and easier. Remove one bolt and the horsehead swings back over the beam. Or remove the horsehead completely. • Perfect alignment with the well is made possible by means of a radiused support between horsehead and beam. Simple adjusting screws make and maintain alignment. • Full side plates designed for maximum safety of your operator.



# GENERAL INFORMATION

When you select Alton Equipment you put almost 65 years of experience to work for you. Since 1889 we have been building dependable equipment for the most exacting requirements of the Petroleum Industry. These many decades have earned us the widespread reputation and fame in whose products you can have complete confidence. Alton's pumping unit line has been expanded and completely redesigned. Alton now makes units of every popular size and makes them better.

If you are now buying pumping units — or contemplate their purchase in the future — compare Alton first. You'll find a carefully built machine in which every part has been ingeniously engineered for long life and quick, easy servicing. No other unit has such a combination of outstanding features. Before it leaves the factory, every Alton unit is pre-tested to assure immediate, uninterrupted field operation. Alton units will positively perform to full rated capacity; each will spend more time operating and less time idled for repairs, maintenance and service.

## ADJUSTABLE COUNTERBALANCE

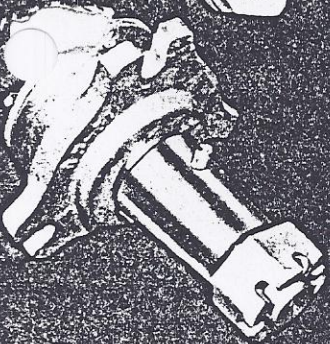
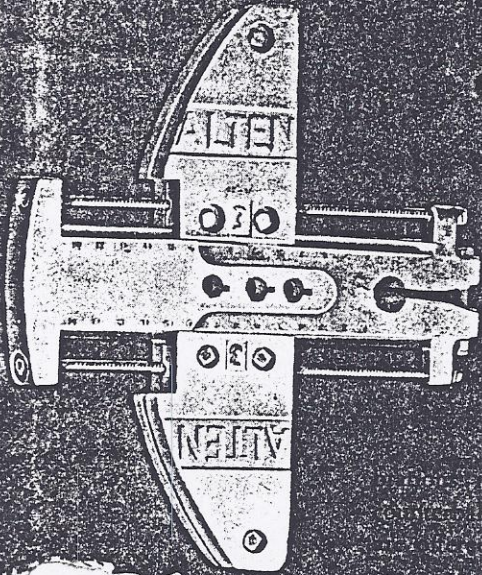

New type adjustable counterbalance incorporates numerous features not found in any other type. Although rugged enough to operate under the most strenuous conditions it is so ingeniously simple that counterbalance weights may be adjusted in a matter of minutes by one man standing on the ground. Screw arrangement gives operator full control at all times; locking device prevents the weights from falling or sliding and positively holds weights in any position at any time. Callipers make it easy to locate weights for desired counterbalance. Interchangeable weights of various sizes are available on all units making necessary only the purchase of the amount of counterbalance essential to the condition.

*Out of Business Oil*

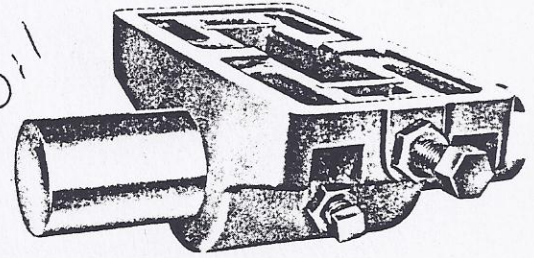

## BRONZED BUSHED SADDLE BEARING

Here is a marked improvement over conventional types. Especially designed with very low bearing pressures, and corrugated grooved, it will give exceptionally long life. Design is such that it may be rotated several times to a new bearing surface. Provision is also made to adjust the walking beam to and from the well so that the polished rod hanger is always properly centered. And finally, the Alton saddle allows lateral adjustment of the walking beam.

*Bremont Oil 614-569 4/11*

## WREST PINS

Large roller wrist pin bearings with which units are equipped have more than ample capacity and are fitted in accordance with those engineering standards that have been proved to give longest life. The tapered hole in the crank. On large units the wrist pin body will rotate if not properly secured. We eliminated all such possibility by pressing a pin into a recess in the front side of the crank. Advantages of standard keys and keyways are eliminated.

## SERVICE BRAKE

Here is the most efficient and convenient brake ever designed for a pumping unit. It is an automotive type that has ample capacity to hold the crank in any position. Rubber gaskets shut out snow or ice and protects against rust.

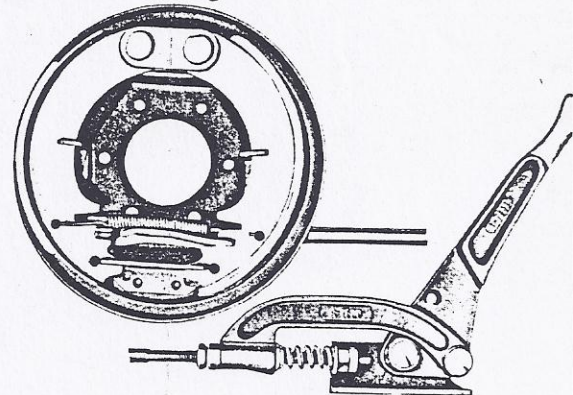

**TYPICAL  
ALTON  
PUMPING UNITS**

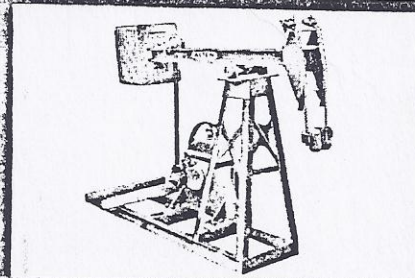

A-2F-6

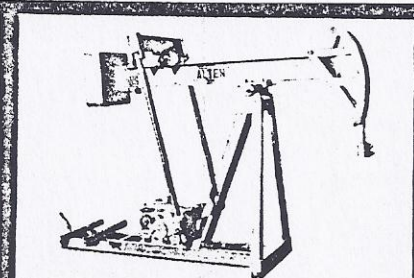

A-4F-16



# GEAR REDUCERS

Alten offers both helical and herringbone gears who need to apply promise; the proper gear train for every application every time.

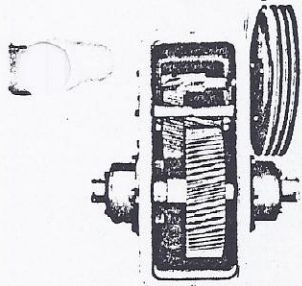

For some wells — particularly in shallow and medium depths where the face width of the gears are relatively narrow and the thrust loads are light — all of the inherent advantages of helical gears are utilized. It is an accepted fact that the hobbing process and crown shaving of helical gears results in extreme accuracy with the stress well distributed for maximum life. Tapered roller bearings are employed on all shafts. Gears and bearings operate in an oil bath which provides positive lubrication at all speeds and temperatures. On wells of greater depth and the corresponding

greater loads the advantages become important. Some of the thrusts producing unnecessary deflection, (2) strong teeth construction, (3) very low torque bearings are used on the floating cylindrical roller bearings on high speed shafts to assure The gears operate in an oil bath which provides positive lubrication at all speeds and temperatures. All Alten reducers have a filter of the housing — thus assu

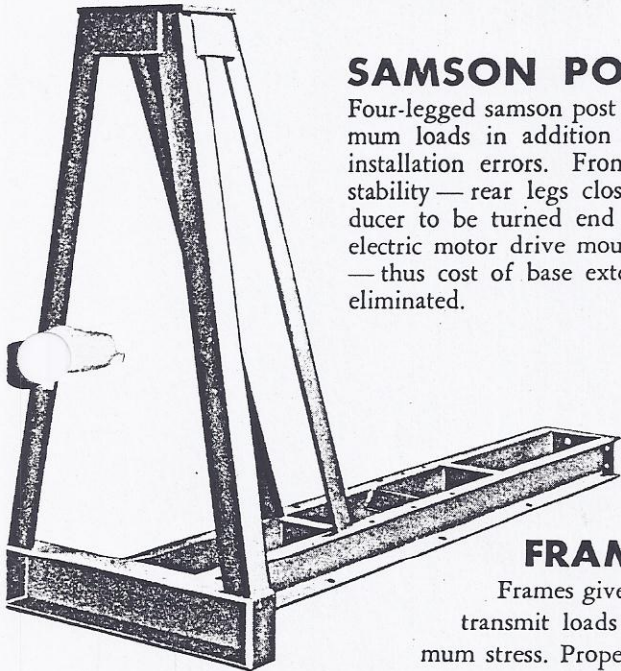
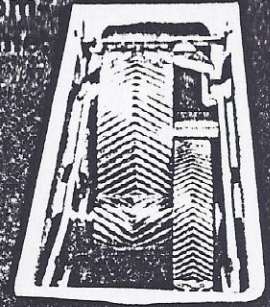

## SAMSON POST

Four-legged samson post rigidly braced to carry maximum loads in addition to loads induced by minor installation errors. Front legs are wide spread for stability — rear legs closely spaced to allow the reducer to be turned end for end at the factory and electric motor drive mounted under the samson post — thus cost of base extension and its foundation is eliminated.

**FRAME** Rugged and heavy, Alten Frames give the unit complete support and transmit loads to the foundation with minimum stress. Proper bracing and anchor bolts are located at all points of stress. On the floor clearing models, the reducer sub-bases are welded to the frame. Most efficient pumping unit geometry is assured by the position of gear reducer.

## EQUALIZER

An "over the beam" type equalizer is a feature of Alten units, thus the problems of bolts in tension — on large all crank balanced units — are eliminated. The equalizer itself is a rolled wide flanged beam which is superior to castings in which there is always a possibility of hidden defects. Equalizer bearings are bronze-bushed for maximum life; convex bottom of the bearing housing allows the equalizer to line up with the walking beam and pitmans.

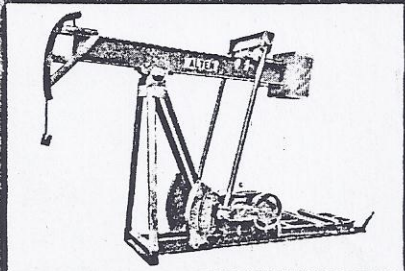

A-5-75

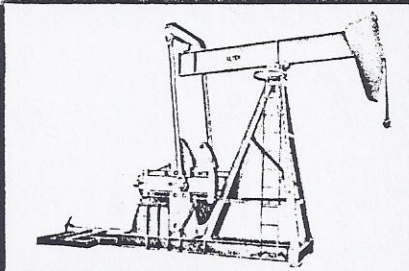

A-12CF-80

← **TYPICAL ALTEN PUMPING UNITS**

**SPECIFICATIONS  
FOR**

**A-2F-6 UNIT**

**ALTEN PUMPING UNIT**

**STRUCTURE**

Unit Structure Rating, A.P.I. ....	2,000 lbs.
Range of Strokes.....	8 1/2" to 14" (Variable)
Well Working Center.....	20"
Well Clearance with Horsehead Removed for Servicing.....	4"
Walking Beam Section and Weight .....	Two 3" 4.1 lb. Channels (8.2 lbs. per Foot)
Length of Walking Beam.....	5'6"
Height of Saddle Bearing Above Top of Foundation .....	3'6"
Overall Length of Base.....	3'7 1/4"
Width of Base at Samson Post.....	16"
Section and Weight of Main Base Members.....	Straight Channel 3", 4.1 lbs.
Section of Pitman.....	1 1/4" Diameter Bar
Saddle, Wrist Pin, and Pitman Bearings, Self-Aligning.....	Bronze
Saddle Bearing Projected Area.....	9 1/2 Square Inches
Type of Counterbalance.....	Beam
Beam Counterweights .....	50 lbs. Each
Weight of Single Crank.....	25 lbs.
Polished Rod Hanger Cable.....	1/2" (6 x 37)
Foundation Bolts .....	1/2" x 12"
Distance from Bottom of Polished Rod Clamp to Top of Foundation at Mid Stroke... ..	2'2 3/4"
Total Weight of Unit Less Beam Weights.....	560 lbs.
Maximum Counterweight Effect at Maximum Polished Rod Stroke.....	1260 lbs.

**GEAR REDUCER**

Peak Torque Rating, A.P.I. ....	6,400 in. lbs.
Nominal Horsepower Rating (at 20 S.P.M.).....	1.3
Reduction Ratio (Single Reduction).....	11.43:1
Weight of Complete Reducer (less Oil).....	210 lbs.
Bearings .....	Ball, Double Row
Sheave Section .....	2 Groove A
Sheave Pitch Diameter (30" Optional).....	22" Std.
Oil Capacity .....	2 1/2 Gallons

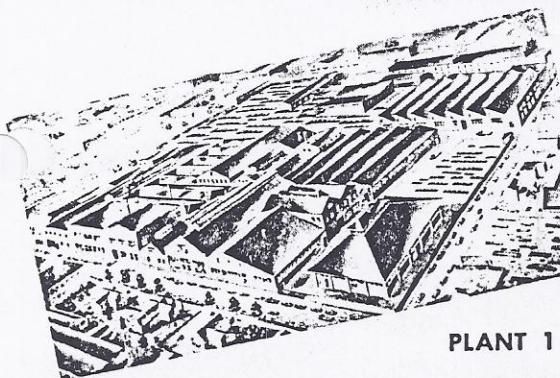

PLANT 1

**ALTEN**

FOUNDRY & MACHINE WORKS INC.  
LANCASTER, OHIO

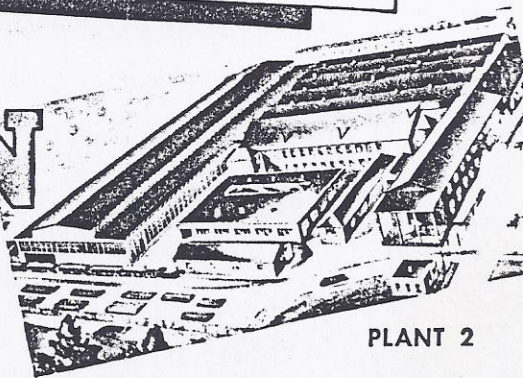

PLANT 2

## A-2F-6 UNIT APPLICATION TABLE

2000 lb. Polished Rod Capacity

6400 in. lb. Torque

STROKE (in.)	PUMP SIZE	MAX. WELL DEPTH, FT.		BARREL Per 24 Hrs.	WELL CALCULATION FACTORS			HP Per 100 Ft.
		Rod Size 5/8			PRL	5/8 Rods PT	CB	
14	1-1/16	1225	30	1.645	1.93	1.370	.044	
	1-1/4	1100	41	1.800	2.49	1.445	.060	
	1-1/2	975	59	2.045	3.36	1.565	.087	
	1-3/4	850	80	2.335	4.45	1.700	.118	
	2	750	104	2.670	5.67	1.860	.153	
	2-1/4	650	132	3.055	7.11	2.040	.194	
	2-1/2	575	163	3.475	8.61	2.245	.240	
	2-3/4	500	197	3.945	10.36	2.465	.290	
	3-3/4	325	367	6.270	18.90	3.570	.540	
	11	1-1/16	1225	23	1.630	1.43	1.370	.034
1-1/4		1125	32	1.780	1.84	1.445	.047	
1-1/2		1000	46	2.025	2.53	1.565	.068	
1-3/4		850	63	2.310	3.36	1.700	.093	
2		750	82	2.645	4.32	1.860	.121	
2-1/4		675	104	3.020	5.39	2.040	.153	
2-1/2		575	128	3.440	6.57	2.245	.188	
2-3/4		500	155	3.905	7.92	2.465	.228	
3-3/4		325	289	6.205	14.50	3.570	.425	
8-1/2		1-1/16	1250	18	1.610	1.02	1.370	.026
	1-1/4	1125	24	1.765	1.36	1.445	.035	
	1-1/2	1000	36	2.005	1.87	1.565	.053	
	1-3/4	875	43	2.290	2.51	1.700	.072	
	2	775	63	2.620	3.23	1.860	.093	
	2-1/4	675	80	2.990	4.04	2.040	.117	
	2-1/2	600	99	3.405	4.93	2.245	.146	
	2-3/4	525	120	3.870	5.97	2.465	.176	
	3-3/4	325	223	6.145	10.94	3.570	.328	

To figure the Polished Rod Load, Peak Torque and Counterbalance required for a well, select the values shown for the length stroke, size pump and size rods to be used and multiply by the number of feet of depth.

**EXAMPLE**

700 ft. well using 5/8" rods, 1-3/4" Pump to be pumped on 14" stroke.

PRL - 2.335 x 700 = 1634.5 Polished Rod Load  
 PT - 4.45 x 700 = 3115 In. Lbs. Peak Torque  
 CB - 1.700 x 700 = 1190 Lbs. Effective Counterbalance.

PRL - Polished Rod Load, lbs. per ft. of depth.  
 PT - Peak Torque, inch lbs. per ft. of depth.  
 CB - Effective Counterbalance, lbs. per ft. of depth.

To determine production or horsepower requirements for speeds other than 20 SPM, divide the values obtained from the tables by 20 and multiply by the number of strokes per minute required.

**EXAMPLE**

Unit to be operated at 15 SPM instead of 20 SPM

Production at 20 SPM - 80 Barrels per day  
 Production at 15 SPM =  $80 \div 20 \times 15 = 60$  Barrels per day.

Horsepower at 20 SPM - 2  
 Horsepower at 15 SPM =  $2 \div 20 \times 15 = 1.5$  HP

All calculations are based on 20 SPM and Specific Gravity of 1.0.

Production values are based on 80% pump efficiency, rod and tubing stretch and overtravel have been neglected.

**SPECIFICATIONS  
FOR**

**A-3F-6 UNIT**

**ALTEN PUMPING UNIT**

**STRUCTURE**

Unit Structure Rating, A.P.I. ....	3,020 lbs.
Range of Strokes. ....	9" to 14" (Variable)
Well Working Center. ....	24"
Well Clearance with Horsehead Removed for Servicing. ....	6"
Walking Beam Section and Weight. ....	6" x 4" Wide Flange 12 lbs.
Length of Walking Beam. ....	6'-7 <sup>7</sup> / <sub>8</sub> "
Height of Saddle Bearing Above Top of Foundation. ....	4'-0"
Overall Length of Base. ....	6' 5 <sup>7</sup> / <sub>8</sub> "
Width of Base at Samson Post. ....	1' - 7-3/16"
Section and Weight of Main Base Members. ....	Straight Channel 4" - 5.4 lbs.
Section of Pitman. ....	1 5/8" Hex. Bar Rated at 20,000 hrs.
Wrist Pin and Pitman Roller Bearings Self-Aligning. ....	Bronze Bushed
Saddle Bearing. ....	14 Square Inches
Saddle Bearing Projected Area. ....	75 lbs. each
Beam Counterweights. ....	25 lbs.
Weight of Single Crank. ....	5/8" (6 x 37)
Polished Rod Hanger Cable. ....	5/8" x 12"
Foundation Bolts. ....	2' - 9 5/8"
Distance from Bottom of Polished Rod Clamp to Top of Foundation at Mid Stroke. ....	800 lbs.
Total Weight of Unit Less Beam Weights. ....	2,265 lbs.
Maximum Counterweight Effect at Maximum Polished Rod Stroke. ....	

**GEAR REDUCER**

Peak Torque Rating, A.P.I. ....	6,400 in. lbs.
Nominal Horsepower Rating (at 20 S.P.M.). ....	1.3
Reduction Ratio (Single Reduction). ....	11.43:1
Weight of Complete Reducer (less Oil). ....	210 lbs.
Bearings. ....	Ball, Double Row
Sheave Section. ....	2 Groove A
Sheave Pitch Diameter (30" Optional). ....	22" Std.
Oil Capacity. ....	2 1/2 Gallons

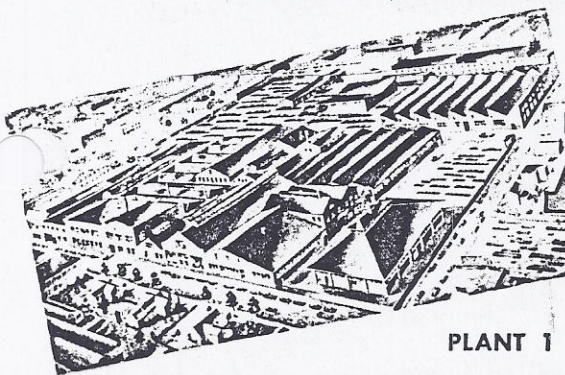

PLANT 1

**ALTEN**

FOUNDRY & MACHINE WORKS INC.  
LANCASTER, OHIO

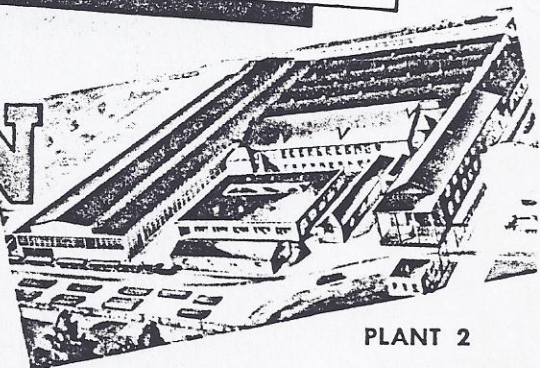

PLANT 2

## A-3F-6 UNIT APPLICATION TABLE

3020 lb. Polished Rod Capacity

6400<sup>✓</sup> in. lb. Torque

STROKE (in.)	PUMP SIZE	MAX. WELL DEPTH, FT.		BARREL Per 24 Hrs.	WELL CALCULATION FACTORS			HP Per 100 Ft.
		Rod Size 5/8			PRL	5/8 Rods PT	CB	
14	1-1/16	1825	30	1.645	1.93	1.370	.044	
	1-1/4	1675	41	1.800	2.49	1.445	.060	
	1-1/2	1475	59	2.045	3.36	1.565	.087	
	1-3/4	1300	80	2.335	4.45	1.700	.118	
	2	1125	104	2.670	5.67	1.860	.153	
	2-1/4	900	132	3.055	7.11	2.040	.194	
	2-1/2	750	163	3.475	8.61	2.245	.240	
	2-3/4	625	197	3.945	10.36	2.465	.290	
	3-3/4	350	367	6.270	18.90	3.570	.540	
11	1-1/16	1850	23	1.630	1.43	1.370	.034	
	1-1/4	1700	32	1.780	1.84	1.445	.047	
	1-1/2	1500	46	2.025	2.53	1.565	.068	
	1-3/4	1300	63	2.310	3.36	1.700	.093	
	2	1150	82	2.645	4.32	1.860	.121	
	2-1/4	1000	104	3.020	5.39	2.040	.153	
	2-1/2	875	128	3.440	6.57	2.245	.188	
	2-3/4	775	155	3.905	7.92	2.465	.228	
	3-3/4	450	289	6.205	14.50	3.570	.425	
9	1-1/16	1875	19	1.615	1.10	1.370	.028	
	1-1/4	1700	26	1.765	1.44	1.445	.038	
	1-1/2	1500	38	2.010	2.00	1.565	.056	
	1-3/4	1300	51	2.295	2.68	1.700	.075	
	2	1150	67	2.625	3.44	1.860	.098	
	2-1/4	1000	85	3.000	4.32	2.040	.125	
	2-1/2	875	105	3.415	5.27	2.245	.154	
	2-3/4	775	127	3.875	6.35	2.465	.187	
	3-3/4	500	236	6.160	11.66	3.570	.347	

To figure the Polished Rod Load, Peak Torque and Counterbalance required for a well, select the values shown for the length stroke, size pump and size rods to be used and multiply by the number of feet of depth.

**EXAMPLE**

700 ft. well using 5/8" rods, 1-3/4" Pump to be pumped on 14" stroke.

PRL - 2.335 x 700 = 1634.5 Polished Rod Load  
 PT - 4.45 x 700 = 3115 In. Lbs. Peak Torque  
 CB - 1.700 x 700 = 1190 Lbs. Effective Counterbalance.

PRL - Polished Rod Load, lbs. per ft. of depth.  
 PT - Peak Torque, inch lbs. per ft. of depth.  
 CB - Effective Counterbalance, lbs. per ft. of depth.

To determine production or horsepower requirements for speeds other than 20 SPM, divide the values obtained from the tables by 20 and multiply by the number of strokes per minute required.

**EXAMPLE**

Unit to be operated at 15 SPM instead of 20 SPM

Production at 20 SPM - 80 Barrels per day  
 Production at 15 SPM = 80 ÷ 20 x 15 = 60 Barrels per day.

Horsepower at 20 SPM - 2  
 Horsepower at 15 SPM = 2 ÷ 20 x 15 = 1.5 HP

All calculations are based on 20 SPM and Specific Gravity of 1.0.

Production values are based on 80% pump efficiency, rod and tubing stretch and overtravel have been neglected.

Counterbalance Table  
A-3F-6 Pumping Unit

No. of Beam Weights--75 lbs. Each	Total Counterbalance Effect at Polished Rod (Lbs.)
Unbalance of Unit.....	65
1.....	255
2.....	430
3.....	605
4.....	775
5.....	945
6.....	1110
7.....	1270
8.....	1425
9.....	1580
10.....	1735
11.....	1885
12.....	2025
13.....	2170
14.....	2310
15.....	2445
16.....	2580

Use Application Table to determine amount of Effective Counterbalance required.

**SPECIFICATIONS  
FOR**

**A-4F-16 UNIT**

**ALTEN PUMPING UNIT**

**STRUCTURE**

Unit Structure Rating, A.P.I. ....	4,020 lbs.
Range of Strokes. ....	18", 20", 23"
Well Working Center. ....	35"
Well Clearance with Horsehead Tipped for Servicing. ....	8- <sup>3</sup> / <sub>4</sub> "
Walking Beam Section and Weight. ....	8" Wide Flange 17 lbs.
Height to Top of Walking Beam Above Top of Foundation. ....	5'-10- <sup>1</sup> / <sub>4</sub> "
Height of Saddle Bearing Above Top of Foundation. ....	4'-11- <sup>3</sup> / <sub>4</sub> "
Overall Length of Base. ....	8'-0- <sup>3</sup> / <sub>4</sub> "
Width of Base at Samson Post. ....	2'-6"
Section and Weight of Main Base Members. ....	Straight Channel 5" - 6.7 lbs.
Section of Pitman. ....	2 <sup>3</sup> / <sub>8</sub> " O.D. Tubular Steel
Wrist Pin Roller Bearings Self Aligning. ....	30,000 Hrs. Min. Life
Saddle and Equalizer Bearings. ....	Bronze Bushed
Saddle Bearing Projected Area. ....	13- <sup>1</sup> / <sub>2</sub> Sq. In.
Equalizer Bearing Projected Area. ....	10 Sq. In.
Beam Counterweights. ....	100 lbs. each
Weight of Twin Cranks. ....	60 lbs. each
Polished Rod Hanger Cable. ....	<sup>5</sup> / <sub>8</sub> " (6 x 37)
Foundation Bolts. ....	<sup>5</sup> / <sub>8</sub> " x 16"
Distance from Bottom of Polished Rod Clamp to Top of Foundation at Bottom of Stroke. ....	1'-6"
Total Weight of Unit Less Beam Weights. ....	1500 lbs.
Maximum Counterweight Effect at Maximum Polished Rod Stroke. ....	2900 lbs.

**GEAR REDUCER**

Peak Torque Rating, A.P.I. ....	16,000 in lbs.
Nominal Horsepower Rating (at 20 S.P.M.). ....	3.5
Reduction Ratio (Double Reduction). ....	33.2:1
Weight of Complete Reducer (less Oil). ....	400 lbs.
Bearings, Tapered Roller. ....	30,000 Hrs. Min. Life
Sheave Section. ....	3 Groove B.
Sheave Pitch Diameter. ....	12- <sup>1</sup> / <sub>2</sub> "
Oil Capacity. ....	3.5 Gallons
Service Brake. ....	Automotive Type

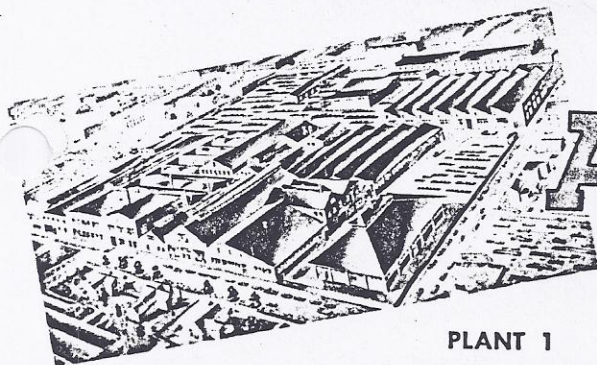

PLANT 1

**ALTEN**

FOUNDRY & MACHINE WORKS INC.  
LANCASTER, OHIO

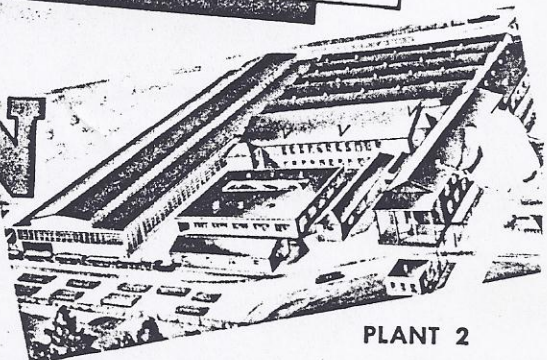

PLANT 2

## A-4F-16 UNIT APPLICATION TABLE

4020 lb. Polished Rod Capacity

16,000 in. lb. Torque

STROKE INCHES	PUMP SIZE	MAX. WELL DEPTH, FT.		BARREL Per 24 HRS.	WELL CALCULATION FACTORS						HP Per 100 FT.
		Rod Size 5/8	Rod Size 3/4		5/8 Rods			3/4 Rods			
					PRL	PT	CB	PRL	PT	CB	
23	1-1/16	2375	1825	49	1.695	3.74	1.370	2.195	4.20	1.830	.072
	1-1/4	2175	1700	67	1.855	4.72	1.445	2.355	5.18	1.905	.098
	1-1/2	1900	1550	96	2.110	6.27	1.565	2.610	6.73	2.025	.141
	1-3/4	1675	1375	131	2.410	8.17	1.700	2.910	8.63	2.160	.193
	2	1450	1250	171	2.755	10.29	1.860	3.255	10.75	2.320	.251
	2-1/4	1250	1100	217	3.150	12.77	2.040	3.650	13.23	2.500	.319
	2-1/2	1050	1000	268	3.585	15.41	2.245	4.085	15.87	2.705	.394
	2-3/4	875	850	324	4.070	18.46	2.465	4.570	18.92	2.925	.476
	3-3/4	475	475	604	6.470	33.35	3.570	6.970	33.81	4.030	.888
	20	1-1/16	2400	1850	42	1.680	3.10	1.370	2.175	3.45	1.830
1-1/4		2200	1725	58	1.840	3.95	1.445	2.330	4.25	1.905	.085
1-1/2		1925	1550	84	2.090	5.25	1.565	2.585	5.60	2.025	.123
1-3/4		1675	1400	114	2.385	6.85	1.700	2.880	7.20	2.160	.167
2		1475	1250	149	2.730	8.70	1.860	3.220	9.00	2.320	.219
2-1/4		1300	1125	189	3.115	10.75	2.040	3.610	11.10	2.500	.278
2-1/2		1125	1000	233	3.550	13.05	2.245	4.045	13.40	2.705	.343
2-3/4		1000	900	282	4.030	15.65	2.465	4.525	16.00	2.925	.415
3-3/4		575	550	525	6.405	28.35	3.570	6.895	28.65	4.030	.770
18		1-1/16	2425	1850	38	1.665	2.66	1.370	2.160	2.97	1.830
	1-1/4	2200	1725	52	1.825	3.42	1.445	2.315	3.69	1.905	.076
	1-1/2	1950	1575	75	2.075	4.59	1.565	2.565	4.86	2.025	.110
	1-3/4	1700	1400	103	2.370	6.03	1.700	2.860	6.30	2.160	.151
	2	1500	1250	134	2.710	7.65	1.860	3.200	7.92	2.320	.197
	2-1/4	1300	1125	170	3.095	9.50	2.040	3.585	9.77	2.500	.250
	2-1/2	1150	1000	210	3.525	11.52	2.245	4.015	11.79	2.705	.309
	2-3/4	1000	900	254	4.000	13.82	2.465	4.490	14.09	2.925	.373
	3-3/4	625	600	472	6.355	25.07	3.570	6.845	25.34	4.030	.694

To figure the Polished Rod Load, Peak Torque and Counterbalance required for a well, select the values shown for the length stroke, size pump and size rods to be used and multiply by the number of feet of depth.

**EXAMPLE**

1500 ft. well using 5/8" rods, 1-3/4" Pump to be pumped on 23" stroke.

PRL - 2.410 x 1500 = 3615 Polished Rod Load  
 PT - 8.17 x 1500 = 12,255 In. Lbs. Peak Torque  
 CB - 1.700 x 1500 = 2550 Lbs. Effective Counterbalance.

PRL - Polished Rod Load, lbs. per ft. of depth.  
 PT - Peak Torque, inch lbs. per ft. of depth.  
 CB - Effective Counterbalance, lbs. per ft. of depth.

Depths are based on Pumping Unit capacity and sucker rod stress has been disregarded.

To determine production or horsepower requirements for speeds other than 20 SPM, divide the values obtained from the tables by 20 and multiply by the number of strokes per minute required.

**EXAMPLE**

Unit to be operated at 15 SPM instead of 20 SPM

Production at 20 SPM - 131 Barrels per day  
 Production at 15 SPM =  $131 \div 20 \times 15 = 98$  Barrels per day.

Horsepower at 20 SPM - 3  
 Horsepower at 15 SPM =  $3 \div 20 \times 15 = 2.25$  HP

All calculations are based on 20 SPM and Specific Gravity of 1.0.

Production values are based on 80% pump efficiency, rod and tubing stretch and overtravel have been neglected.



Counterbalance Table  
A-4F-16 Pumping Unit

No. of Beam Weights--100 lbs. Each	Total Counterbalance Effect at Polished Rod (Lbs.)		
	18" Stroke	20" Stroke	23" Stroke
Unbalance of Unit.....	325	285	250
1.....	520	480	445
2.....	715	675	640
3.....	905	865	830
4.....	1095	1055	1020
5.....	1280	1240	1205
6.....	1460	1420	1385
7.....	1640	1600	1565
8.....	1820	1780	1745
9.....	1995	1955	1920
10.....	2165	2125	2090
11.....	2335	2295	2260
12.....	2500	2460	2425
13.....	2660	2620	2585
14.....	2820	2780	2750
15.....	2980	2940	2900
16.....	3140	3100	3065
17.....	3290	3250	3215
18.....	3440	3400	3365

Use Application Table to determine amount of Effective Counterbalance required.

**STRUCTURE**

Unit Structure Rating, A.P.I. ....	5100 lb.
Range of Strokes. ....	18"-20"-26"-28"
Well Working Center. ....	3'-6"
Well Clearance with Horsehead Tipped for Servicing. ....	9-3/8"
Walking Beam Section and Weight. ....	10" Wide Flange 21 lbs.
Height to Top of Walking Beam Above Top of Foundation. ....	7'-1"
Height of Saddle Bearing Above Top of Foundation. ....	6'-0-1/2"
Overall Length of Base. ....	9'-9"
Width of Base at Samson Post. ....	2'-10"
Section and Weight of Main Base Members. ....	Straight Channel 6" - 8.2 lbs.
Section of Pitman. ....	2 3/8" O.D. Tubular Steel
Wrist Pin Roller Bearings Self Aligning. ....	30,000 Hrs. Min. Life
Saddle and Equalizer Bearings. ....	Bronze Bushed
Saddle Bearing Projected Area. ....	21 Sq. In.
Equalizer Bearing Projected Area. ....	10 Sq. In.
Beam Counterweights. ....	110 Lbs. Each
Weight of Twin Cranks. ....	85 Lbs. Each
Weight of Master Crank Weights. ....	96 Lbs. Each
Weight of Auxiliary Crank Weights. ....	98 Lbs. Each
Polished Rod Hanger Cable. ....	5/8" (6 x 37) 3/4" x 16"
Foundation Bolts. ....	2-0-5/8"
Distance from Bottom of Polished Rod Clamp to Top of Foundation at Bottom of Stroke. ....	2300 lbs.
Total Weight of Unit Less Beam Weights. ....	3645 lbs.
Maximum Counterweight Effect at Maximum Polished Rod Stroke. ....	

**GEAR REDUCER**

Peak Torque Rating, ....	25,000 in. lbs.
Nominal Horsepower Rating (at 20 S.P.M.). ....	5
Reduction Ratio (Double Reduction). ....	28.4:1
Weight of Complete Reducer (less Oil). ....	520 lbs.
Bearings, Tapered Roller. ....	30,000 Hrs. Min. Life
Sheave Section. ....	3 Groove B
Sheave Pitch Diameter. ....	16-1/8"
Oil Capacity. ....	5 Gallons
Service Brake. ....	Automotive Type

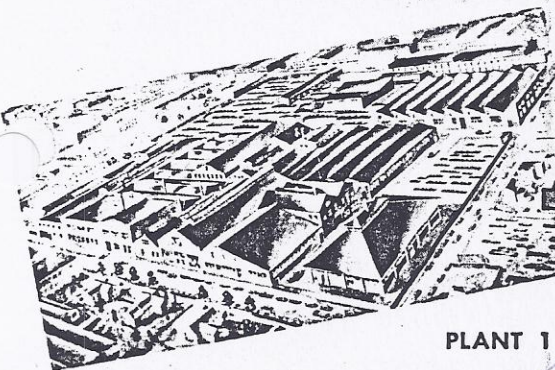

PLANT 1

**ALTEN**

**FOUNDRY & MACHINE WORKS INC.  
LANCASTER, OHIO**

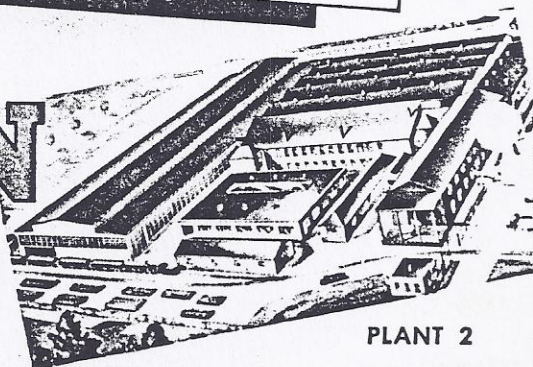

PLANT 2

STROKE INCHES	PUMP SIZE	MAX. WELL DEPTH, FT.			BARREL Per 24 HRS.	WELL CALCULATION FACTORS						HP Per 100 FT.	
		5/8	3/4	3/4		5/8--3/4 Rods		% 3/4 RODS		3/4 Rods			
		2975	2725	2300	PRL	PT	CB	PRL	PT	CB	PRL	PT	CB
28	1-1/16	2700	2475	2150	59	1.880	5.18	1.510	30.5	1.830	2.235	5.67	1.830
	1-1/4	2375	2175	1925	82	2.060	6.44	1.600	33.2	1.905	2.395	6.86	1.905
	1-1/2				117	2.340	8.47	1.735	37.4	2.025	2.655	8.82	2.025
	1-3/4	2100	1925	1725	160	2.665	10.78	1.895	42.3	2.160	2.960	11.20	2.160
	2	1825	1675	1550	209	3.050	13.58	2.080	48.2	2.320	3.310	13.86	2.320
	2-1/4	1525	1475	1375	264	3.480	16.66	2.290	54.4	2.500	3.710	16.94	2.500
26	2-1/2	1275	1250	1225	326	3.965	20.10	2.530	63.0	2.705	4.155	20.30	2.705
	2-3/4	1075	1050	1025	395	4.495	23.94	2.785	69.7	2.925	4.650	24.15	2.925
	3-3/4	600		575	735	6.580	42.14	3.570		4.030	7.090	42.84	4.030
	1-1/16	3000	2750	2300	55	1.870	4.68	1.510	30.5	1.830	2.220	5.07	1.830
	1-1/4	2725	2500	2150	76	2.045	5.79	1.600	33.2	1.905	2.380	6.18	1.905
	1-1/2	2400	2200	1950	109	2.320	7.61	1.735	37.4	2.025	2.635	7.93	2.025
20	1-3/4	2100	1925	1750	149	2.650	9.82	1.895	42.3	2.160	2.940	10.14	2.160
	2	1850	1700	1550	194	3.025	12.29	2.080	48.2	2.320	3.290	12.61	2.320
	2-1/4	1600	1475	1400	245	3.455	15.15	2.290	54.4	2.500	3.685	15.41	2.500
	2-1/2	1400	1300	1250	303	3.940	18.33	2.530	63.0	2.705	4.125	18.46	2.705
	2-3/4	1175	1150	1100	367	4.465	21.84	2.785	69.7	2.925	4.615	21.97	2.925
	3-3/4	650		650	682	6.535	38.55	3.570		4.030	7.040	39.13	4.030
20	1-1/16	3050	2800	2350	42	1.830	3.20	1.510	30.5	1.830	2.175	3.45	1.830
	1-1/4	2775	2550	2200	58	2.000	4.00	1.600	33.2	1.905	2.330	4.25	1.905
	1-1/2	2450	2250	1975	84	2.275	5.40	1.735	37.4	2.025	2.585	5.60	2.025
	1-3/4	2150	1975	1775	114	2.595	7.00	1.895	42.3	2.160	2.880	7.20	2.160
	2	1875	1725	1600	149	2.965	8.85	2.080	48.2	2.320	3.220	9.00	2.320
	2-1/4	1650	1500	1425	189	3.385	10.95	2.290	54.4	2.500	3.610	11.10	2.500
20	2-1/2	1450	1325	1275	233	3.860	13.30	2.530	63.0	2.705	4.045	13.40	2.705
	2-3/4	1275	1175	1125	282	4.375	15.90	2.785	69.7	2.925	4.525	16.00	2.925
	3-3/4	800		750	525	6.405	28.35	3.570		4.030	6.900	28.70	4.030

To figure the Polished Rod Load, Peak Torque and Counterbalance required for a well, select the values shown for the length stroke, size pump and size rods to be used and multiply by the number of feet of depth.  
 EXAMPLE--2000 ft. well using 5/8" Rods, 1-3/4" Pump to be pumped on 28" stroke.  
 PRL - 2,450 x 2000 = 4900 Polished Rod Load  
 PT - 10.50 x 2000 = 21,000 In. Lbs. Peak Torque  
 CB - 1,700 x 2000 = 3400 Lbs. Effective Counterbalance.

To determine production or horsepower requirements for speeds other than 20 SPM, divide the values obtained from the tables by 20 and multiply by the number of strokes per minute required.  
 EXAMPLE--Unit to be operated at 15 SPM instead of 20 SPM.  
 Production at 20 SPM = 160 Barrels per day  
 Production at 15 SPM = 160 ÷ 20 x 15 = 120 Barrels per day.  
 Horsepower at 20 SPM = 4  
 Horsepower at 15 SPM = 4 ÷ 20 x 15 = 3 HP

PRL - Polished Rod Load, lbs. per ft. of depth.  
 PT - Peak Torque, inch lbs. per ft. of depth.  
 CB - Effective Counterbalance, lbs. per ft. of depth.  
 Depths are based on Pumping Unit capacity and sucker rod stress has been disregarded.  
 All calculations are based on 20 SPM and Specific Gravity of 1.0.  
 Production values are based on 80% pump efficiency, rod and tubing stretch and overtravel have been neglected.

Counterbalance Table  
A-5-25 Pumping Unit

No. of Beam Weights--110 lbs. Each	Total Counterbalance Effect at Polished Rod (Lbs.)			
	18" Stroke	20" Stroke	26" Stroke	28" Stroke
Cranks Only.....	420	350	330	270
Cranks and Crank Weights.....	1310	1150	950	840
1.....	1495	1335	1135	1025
2.....	1680	1520	1320	1210
3.....	1860	1700	1500	1390
4.....	2040	1880	1680	1570
5.....	2215	2055	1855	1745
6.....	2390	2230	2030	1920
7.....	2560	2400	2200	2090
8.....	2730	2570	2370	2260
9.....	2895	2735	2535	2425
10.....	3060	2900	2700	2590
11.....	3220	3060	2860	2750
12.....	3380	3220	3020	2910
13.....	3535	3375	3175	3065
14.....	3690	3530	3330	3220
15.....	3840	3680	3480	3370
16.....	3990	3830	3630	3520
17.....	4135	3975	3775	3665
18.....	4275	4115	3915	3805
19.....	4415	4255	4055	3945
20.....		4390	4190	4080
21.....				4215

Use Application Table to determine amount of Effective Counterbalance required.

**SPECIFICATIONS  
FOR**

**A-8-40 UNIT**

**ALTEN PUMPING UNIT**

**STRUCTURE**

Unit Structure Rating, A.P.I. ....	8210 lbs.
Range of Strokes .....	20", 27", 34"
Well Working Center .....	48"
Well Clearance with Horsehead Tipped for Servicing .....	10 1/8"
Walking Beam Section and Weight .....	12"
	Wide Flange 31 lbs.
	7'9"
Height to Top of Walking Beam Above Top of Foundation .....	6'6"
Height of Saddle Bearing Above Top of Foundation .....	12'5 3/4"
Overall Length of Base .....	3'2 3/4"
Width of Base at Samson Post .....	Straight Channel
Section and Weight of Main Base Members .....	8" - 11.5 lbs.
	2 1/2" Std. Pipe
Section of Pitman .....	30,000 Hrs. Min. Life
Wrist Pin Roller Bearings Self Aligning .....	Bronze Bushed
Saddle and Equalizer Bearings .....	31 1/2 Sq. In.
Saddle Bearing Projected Area .....	19 1/2 Sq. In.
Equalizer Bearing Projected Area .....	120 lbs. each
Beam Counterweights .....	160 lbs. each
Weight of Twin Cranks .....	125 lbs. each
Weight of Master Crank Weights .....	120 lbs. each
Weight of Auxiliary Crank Weights .....	3/4" (6 x 37)
Polished Rod Hanger Cable .....	7/8" x 16"
Foundation Bolts .....	2'2 1/2"
Distance from Bottom of Polished Rod Clamp to Top of Foundation at Bottom of Stroke .....	3515 lbs.
Total Weight of Unit Less Beam Weights .....	5300 lbs.
Maximum Counterweight Effect at Maximum Polished Rod Stroke .....	

**GEAR REDUCER**

Peak Torque Rating, A.P.I. ....	40,000 in. lbs.
Nominal Horsepower Rating (at 20 S.P.M.) .....	8
Reduction Ratio (Double Reduction) .....	28.4:1
Weight of Complete Reducer (less Oil) .....	860 lbs.
Bearings, Tapered Roller .....	30,000 Hrs. Min. Life
Sheave Section .....	4 Groove B
Sheave Pitch Diameter .....	16 3/4"
Oil Capacity .....	8 1/2 Gallons
Service Brake .....	Automotive Type

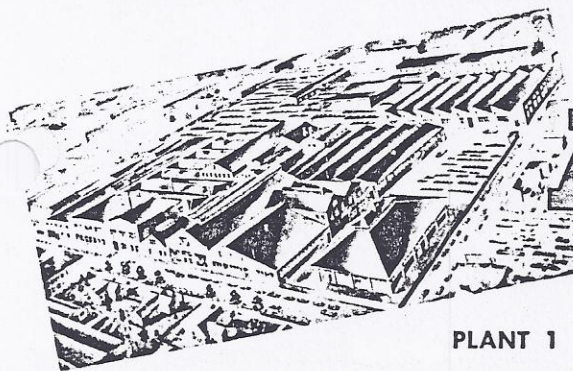

PLANT 1

**ALTEN**

FOUNDRY & MACHINE WORKS INC.  
LANCASTER, OHIO

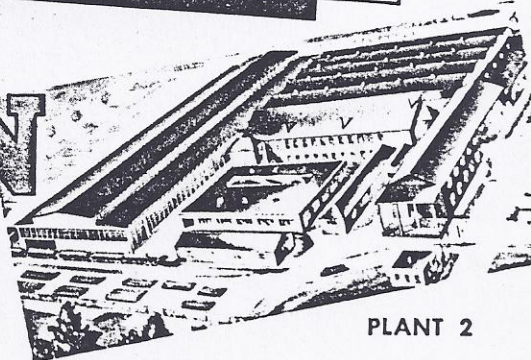

PLANT 2

A-8-40 UNIT APPLICATION TABLE

STROKE INCHES	PUMP SIZE	MAX. WELL DEPTH, FT.		BARREL Per 24 HRS.	WELL CALCULATION FACTORS						HP Per 100 FT.							
		Rod Size			5/8 Rods		5/8-3/4 Rods		% 3/4 RODS	3/4 Rods								
		5/8	3/4		PRL	PT	PRL	PT		PRL		PT	CB					
34	1-1/16	4350	3975	3350	72	1.760	6.63	1.370	1.510	1.920	6.97	1.510	30.5	2.280	7.65	1.830	.106	
	1-1/4	3975	3900	3125	99	1.925	8.16	1.445	1.600	2.100	8.50	1.600	33.2	2.445	9.18	1.905	.146	
	1-1/2	3500	3450	2825	143	2.190	10.63	1.565	1.735	2.385	11.05	1.735	37.4	2.710	11.65	2.025	.211	
	2	2950	2850	2525	194	2.500	13.60	1.700	1.895	2.720	14.03	1.895	42.3	3.020	14.62	2.160	.286	
	2-1/4	2350	2275	2225	254	2.860	17.00	1.860	2.080	3.110	17.51	2.080	48.2	3.380	18.02	2.320	.374	
	3-3/4	1900	1875	1825	321	3.270	20.91	2.040	2.290	3.550	21.42	2.290	54.4	3.785	21.85	2.500	.473	
	2-1/2	1600	1550	1525	396	3.720	25.08	2.245	2.530	4.045	25.76	2.530	63.0	4.240	26.10	2.705	.583	
	2-3/4	1325	1300	1300	479	4.225	29.92	2.465	2.785	4.585	30.60	2.785	69.7	4.745	30.94	2.925	.706	
	3-3/4	750	725	725	892	6.715	53.47	3.570						7.230	54.40	4.030	1.314	
	27	1-1/16	4775	4375	3700	57	1.720	4.73	1.370	1.510	1.875	4.93	1.510	30.5	2.225	5.33	1.830	.084
		1-1/4	4375	4000	3425	79	1.880	5.87	1.445	1.600	2.050	6.08	1.600	33.2	2.390	6.55	1.905	.116
		1-1/2	3825	3525	3100	113	2.140	7.76	1.565	1.735	2.330	8.03	1.735	37.4	2.645	8.37	2.025	.166
2		3350	3075	2775	154	2.445	10.06	1.700	1.895	2.660	10.33	1.895	42.3	2.950	10.67	2.160	.227	
2-1/4		2950	2700	2500	201	2.795	12.62	1.860	2.080	3.035	12.90	2.080	48.2	3.300	13.23	2.320	.296	
3-3/4		2125	2075	2225	255	3.190	15.53	2.040	2.290	3.470	15.93	2.290	54.4	3.700	16.20	2.500	.376	
2-1/2		1775	1750	1975	315	3.635	18.77	2.245	2.530	3.950	19.17	2.530	63.0	4.140	19.37	2.705	.464	
2-3/4		1000	975	975	381	4.125	22.41	2.465	2.785	4.480	22.88	2.785	69.7	4.635	23.09	2.925	.561	
3-3/4		4875	4475	3775	708	6.560	40.37	3.570						7.065	40.97	4.030	1.043	
20		1-1/16	4875	4475	3775	42	1.680	3.10	1.370	1.510	1.830	3.20	1.510	30.5	2.175	3.45	1.830	.062
		1-1/4	4450	4100	3525	58	1.840	3.95	1.445	1.600	2.000	4.00	1.600	33.2	2.330	4.25	1.905	.085
		1-1/2	3925	3600	3175	84	2.090	5.25	1.565	1.735	2.275	5.40	1.735	37.4	2.585	5.60	2.025	.124
	2	3450	3175	2850	114	2.385	6.85	1.700	1.895	2.595	7.00	1.895	42.3	2.880	7.20	2.160	.168	
	2-1/4	3000	2775	2550	149	2.780	8.70	1.860	2.080	2.965	8.85	2.080	48.2	3.220	9.00	2.320	.219	
	3-3/4	2625	2425	2275	189	3.115	10.75	2.040	2.290	3.385	10.95	2.290	54.4	3.610	11.10	2.500	.278	
	2-1/2	2300	2125	2025	233	3.550	13.05	2.245	2.530	3.860	13.40	2.530	63.0	4.045	13.40	2.705	.333	
	2-3/4	2025	1875	1825	282	4.030	15.65	2.465	2.785	4.375	15.90	2.785	69.7	4.525	16.00	2.925	.415	
	3-3/4	1275	1200	1200	525	6.405	28.35	3.570						6.895	28.65	4.030	.773	

To figure the Polished Rod Load, Peak Torque and Counterbalance required for a well, select the values shown for the length stroke, size pump and size rods to be used and multiply by the number of feet of depth.  
 EXAMPLE--2500 ft. well using 3/4" Rods, 1-3/4" Pump to be pumped on 34" stroke.  
 PRL - 3.020 x 2500 = 7550 Polished Rod Load  
 PT - 14.62 x 2500 = 36,550 In. Lbs. Peak Torque  
 CB - 2.160 x 2500 = 5400-Lbs. Effective Counterbalance.

To determine production or horsepower requirements for speeds other than 20 SPM, divide the values obtained from the tables by 20 and multiply by the number of strokes per minute required.  
 EXAMPLE--Unit to be operated at 15 SPM instead of 20 SPM.  
 Production at 15 SPM - 194 Barrels per day  
 Barrels per day.  
 Horsepower at 20 SPM - 7  
 Horsepower at 15 SPM = 7 - 20 x 15 = 5.25

PRL - Polished Rod Load, lbs. per ft. of depth.  
 PT - Peak Torque, inch lbs. per ft. of depth.  
 CB - Effective Counterbalance, lbs. per ft. of depth.  
 Depths are based on Pumping Unit capacity and sucker rod stress has been disregarded.  
 All calculations are based on 20 SPM and Specific Gravity of 1.0.  
 Production values are based on 80% pump efficiency, rod and tubing stretch and overtravel have been neglected.

Counterbalance Table  
A-8-40 Pumping Unit

No. of Beam Weights--120 lbs. Each	Total Counterbalance Effect at Polished Rod (Lbs.)		
	20" Stroke	27" Stroke	34" Stroke
Crank Only.....	580	530	485
Crank and Crank Weights.....	1885	1480	1220
1.....	2085	1680	1420
2.....	2280	1875	1615
3.....	2475	2070	1810
4.....	2670	2265	2005
5.....	2855	2450	2190
6.....	3045	2640	2380
7.....	3230	2825	2565
8.....	3410	3005	2745
9.....	3590	3185	2925
10.....	3765	3360	3100
11.....	3940	3535	3275
12.....	4110	3705	3445
13.....	4280	3875	3615
14.....	4445	4040	3780
15.....	4610	4205	3945
16.....	4770	4365	4105
17.....	4930	4525	4265
18.....	5085	4680	4420
19.....	5235	4830	4570
20.....	5390	4985	4725
21.....	5535	5130	4870
22.....	5680	5275	5015
23.....	5825	5420	5160
24.....	5965	5560	5300

Use Application Table to determine amount of Effective Counterbalance required.

**SPECIFICATIONS  
FOR**

**A-10F-57 UNIT**

**ALTEN PUMPING UNIT**

**STRUCTURE**

Unit Structure Rating, A.P.I. ....	10,450 lbs.
Range of Strokes .....	24", 33", 42"
Well Working Center .....	5'0"
Walking Beam Section and Weight .....	1'3"
Well Clearance with Horsehead Tipped for Servicing .....	14" Wide Flange 43#
Walking Beam Section and Weight .....	10'11 3/8"
Height to Top of Walking Beam Above Top of Foundation .....	9'6"
Height of Saddle Bearing Above Top of Foundation .....	16'4"
Overall Length of Base .....	3'11 3/4"
Width of Base at Samson Post .....	Wide Flange
Section and Weight of Main Base Members .....	8" - 17 lbs.
Section of Pitman .....	2 1/2" Std. Pipe
Wrist Pin Roller Bearings Self Aligning .....	30,000 Hrs. Min. Life
Saddle and Equalizer Bearings .....	Bronze Bushed
Saddle Bearing Projected Area .....	44 Sq. In.
Equalizer Bearing Projected Area .....	19 1/2 Sq. In.
Beam Counterweights .....	500 lbs. each
Weight of Twin Cranks .....	390 lbs. each
Weight of Master Crank Weights .....	285 lbs. each
Weight of Auxiliary Crank Weights .....	155 lbs. each
Polished Rod Hanger Cable .....	3/4" (6 x 37)
Foundation Bolts .....	1" x 20"
Distance from Bottom of Polished Rod Clamp to Top of Foundation at Bottom of Stroke .....	4'6 1/2"
Total Weight of Unit Less Beam Weights .....	6410 lbs.
Maximum Counterweight Effect at Maximum Polished Rod Stroke .....	8210 lbs.

**GEAR REDUCER**

Peak Torque Rating, A.P.I. ....	57,000 in. lbs.
Nominal Horsepower Rating (at 20 S.P.M.) .....	11.5
Reduction Ratio (Double Reduction) .....	30.9:1
Weight of Complete Reducer (less Oil) .....	1580 lbs.
Bearings, Tapered Roller .....	30,000 Hrs. Min. Life
Sheave Section .....	3 Groove C
Sheave Pitch Diameter .....	19"
Oil Capacity .....	7 Gallons
Service Brake .....	Automotive Type

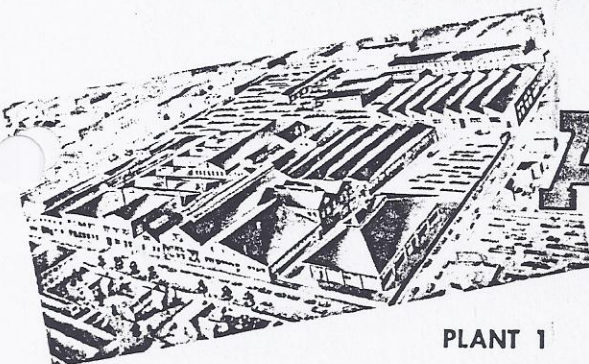

PLANT 1

**ALTEN**

FOUNDRY & MACHINE WORKS INC.  
LANCASTER, OHIO

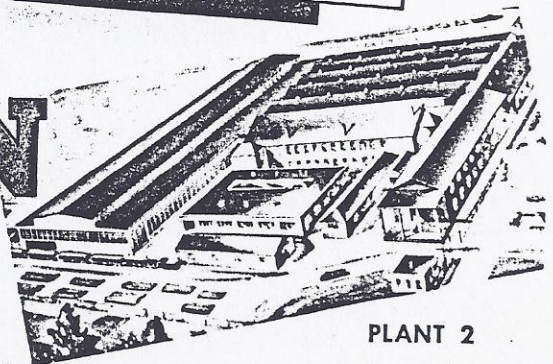

PLANT 2



A-10F-57 UNIT APPLICATION TABLE

STROKE INCHES	PUMP SIZE	MAX. WELL DEPTH, FT.		BARREL Per 24 HRS.	WELL CALCULATION FACTORS						HP Per 100 FT.					
		5/8	Rod Size 5/8-3/4		3/4	5/8 Rods		5/8-3/4 Rods		3/4 Rods						
					PRL	PT	CB	PRL	PT	CB	% 3/4 RODS	PRL	PT	CB		
42	1-1/16	5775	5300	4475	89	1.810	9.24	1.370	1.970	9.66	1.510	30.5	2.340	10.71	1.830	.131
	1-1/4	5075	4850	4175	122	1.980	11.24	1.445	2.155	11.66	1.600	33.2	2.510	12.71	1.905	.180
	1-1/2	3950	3800	3600	176	2.250	14.39	1.565	2.450	15.02	1.735	37.4	2.780	15.86	2.025	.259
	2	3150	3025	2900	240	2.565	18.17	1.700	2.795	18.90	1.895	42.3	3.100	19.74	2.160	.354
	2-1/4	2525	2450	2350	313	2.935	22.58	1.860	3.190	23.30	2.080	48.2	3.470	24.15	2.320	.461
	3-3/4	2075	2000	1950	396	3.355	27.61	2.040	3.645	28.46	2.290	54.4	3.885	29.09	2.500	.583
33	1-1/16	1725	1675	1650	489	3.820	33.08	2.245	4.155	34.13	2.530	63.0	4.350	34.55	2.705	.720
	1-1/4	1450	1425	1400	592	4.335	39.27	2.465	4.705	40.32	2.785	69.7	4.860	40.64	2.925	.872
	1-1/2	825	800	800	1102	6.890	69.72	3.570	7.425	71.30	4.030	1.102	7.425	71.30	4.030	1.102
	2	5950	5475	4600	70	1.755	6.35	1.370	1.910	6.60	1.510	30.5	2.270	7.26	1.830	.103
	2-1/4	3500	3375	3100	96	1.920	7.84	1.445	2.090	8.09	1.600	33.2	2.435	8.75	1.905	.141
	3-3/4	2850	2775	2725	138	2.180	10.15	1.565	2.375	10.56	1.735	37.4	2.700	11.14	2.025	.203
24	1-1/16	4200	3850	3475	188	2.490	13.04	1.700	2.711	13.46	1.895	42.3	3.010	14.03	2.160	.277
	1-1/4	3500	3375	3100	246	2.850	16.34	1.860	3.100	16.83	2.080	48.2	3.365	17.24	2.320	.362
	1-1/2	2850	2775	2725	312	3.255	20.05	2.040	3.535	20.54	2.290	54.4	3.770	20.96	2.500	.460
	2	2350	2300	2275	384	3.710	24.17	2.245	4.030	24.75	2.530	63.0	4.225	25.08	2.705	.566
	2-1/4	1975	1925	1925	465	4.210	28.80	2.465	4.570	29.45	2.785	69.7	4.725	29.70	2.925	.685
	3-3/4	1100	1075	1075	866	6.690	51.48	3.570	7.205	52.39	4.030	1.726	7.205	52.39	4.030	1.726
24	1-1/16	6150	5625	4750	51	1.700	3.96	1.370	1.855	4.14	1.510	30.5	2.200	4.44	1.830	.075
	1-1/4	5600	5150	4425	70	1.860	4.98	1.445	2.030	5.16	1.600	33.2	2.360	5.46	1.905	.103
	1-1/2	4950	4525	4000	101	2.115	6.60	1.565	2.305	6.84	1.735	37.4	2.615	7.08	2.025	.149
	2	4325	3975	3575	137	2.415	8.58	1.700	2.630	8.82	1.895	42.3	2.915	9.06	2.160	.202
	2-1/4	3775	3475	3200	179	2.765	10.86	1.860	3.005	11.10	2.080	48.2	3.265	11.34	2.320	.254
	3-3/4	3300	3050	2850	227	3.155	13.38	2.040	3.430	13.68	2.290	54.4	3.660	13.92	2.500	.334
24	2-1/2	2900	2675	2550	280	3.595	16.20	2.245	3.910	16.56	2.530	63.0	4.095	16.68	2.705	.412
	2-3/4	2550	2350	2275	338	4.080	19.38	2.465	4.430	19.74	2.785	69.7	4.585	19.92	2.925	.498
	3-3/4	1600	1500	1500	630	6.485	34.98	3.570	6.485	34.98	3.570	63.0	6.985	35.46	4.030	.928

To figure the Polished Rod Load, Peak Torque and Counterbalance required for a well, select the values shown for the length stroke, size pump and size rods to be used and multiply by the number of feet of depth.  
 EXAMPLE--2600 ft. well using 3/4" Rods, 1-3/4" Pump to be pumped on 42" Stroke.  
 PRL - 3100 x 2600 = 8060 Polished Rod Load  
 PT - 19.74 x 2600 = 51,324 In. Lbs. Peak Torque  
 CB - 2.160 x 2600 = 5616 Lbs. Effective Counterbalance.

To determine production or horsepower requirements for speeds other than 20 SPM, divide the values obtained from the tables by 20 and multiply by the number of strokes per minute required.  
 EXAMPLE--Unit to be operated at 15 SPM instead of 20 SPM  
 Production at 20 SPM - 240 Barrels per day  
 Production at 15 SPM = 240 ÷ 20 x 15 = 180 Barrels per day.  
 Horsepower at 20 SPM - 9.2  
 Horsepower at 15 SPM = 9.2 ÷ 20 x 15 = 6.9 HP

PRL - Polished Rod Load, lbs. per ft. of depth.  
 PT - Peak Torque, inch lbs. per ft. of depth.  
 CB - Effective Counterbalance, lbs. per ft. of depth.  
 Depths are based on Pumping Unit capacity and sucker rod stresses has been disregarded.  
 All calculations are based on 20 SPM and Specific Gravity of 1.0.  
 Production values are based on 80% pump efficiency, rod and tubing stretch and overtravel have been neglected.

Counterbalance Table  
A-10F-57 Pumping Unit

No. of Beam Weights--500 lbs. Each	Total Counterbalance Effect at Polished Rod (Lbs.)		
	24" Stroke	33" Stroke	42" Stroke
Crank and Crank Weights	3430	2670	2230
1.....	4380	3620	3180
2.....	5290	4530	4090
3.....	6170	5410	4970
4.....	7020	6260	5820
5.....	7850	7090	6650
6.....	8650	7890	7450
7.....	9410	8650	8210
8.....		9390	8950

Use Application Table to determine amount of Effective Counterbalance required.

# A-10CF-57 UNIT APPLICATION TABLE

10,450 lb. Polished Rod Capacity

57,000 in. lb. Torque

STROKE INCHES	PUMP SIZE	MAX. WELL DEPTH, FT.		BARREL Per 24 HRS.	WELL CALCULATION FACTORS						HP Per 100 FT.					
		5/8	Rod Size 5/8-3/4 3/4		5/8 Rods PRL	5/8-3/4 Rods PT	CB	% 3/4 RODS	3/4 Rods PRL	3/4 Rods PT		CB				
42	1-1/16	5775	5300	4475	89	1.810	9.24	1.370	1.970	9.66	1.510	30.5	2.340	10.71	1.830	.131
	1-1/4	5075	4850	4175	122	1.980	11.24	1.445	2.155	11.66	1.600	33.2	2.510	12.71	1.905	.180
	1-1/2	3950	3800	3600	176	2.250	14.39	1.565	2.450	15.02	1.735	37.4	2.780	15.86	2.025	.258
	1-3/4	3150	3025	2900	240	2.565	18.17	1.700	2.795	18.90	1.895	42.3	3.100	19.74	2.160	.354
	2	2525	2450	2350	313	2.935	22.58	1.860	3.190	23.30	2.080	48.2	3.470	24.15	2.320	.461
	2-1/4	2075	2000	1950	396	3.355	27.61	2.040	3.645	28.46	2.290	54.4	3.885	29.09	2.500	.583
32	2-1/2	1725	1675	1650	489	3.520	33.08	2.245	4.155	34.13	2.530	63.0	4.350	34.55	2.705	.720
	2-3/4	1450	1425	1400	592	4.335	39.27	2.465	4.705	40.32	2.785	69.7	4.860	40.64	2.925	.872
	3-3/4	825	800	800	1102	6.890	69.72	3.570					7.425	71.30	4.030	1.623
	1-1/16	5975	5475	4625	68	1.750	6.08	1.370	1.905	6.32	1.510	30.5	2.265	6.96	1.830	.100
	1-1/4	5450	5000	4300	93	1.915	7.52	1.445	2.085	7.76	1.600	33.2	2.430	8.40	1.905	.137
	1-1/2	4800	4400	3875	134	2.175	9.76	1.565	2.370	10.16	1.735	37.4	2.690	10.65	2.025	.197
22	1-3/4	4200	3875	3475	183	2.485	12.56	1.700	2.705	12.96	1.895	42.3	3.000	13.44	2.160	.269
	2	3625	3375	3125	239	2.840	15.68	1.860	3.090	16.16	2.080	48.2	3.355	16.56	2.320	.351
	2-1/4	2950	2875	2775	302	3.245	19.28	2.040	3.525	19.76	2.290	54.4	3.760	20.16	2.500	.444
	2-1/2	2450	2400	2350	373	3.700	23.28	2.245	4.020	23.84	2.530	63.0	4.215	24.16	2.705	.548
	2-3/4	2050	2000	2000	451	4.200	27.76	2.465	4.555	28.32	2.785	69.7	4.715	28.64	2.925	.663
	3-3/4	1150	1125	1125	840	6.670	49.60	3.570					7.185	50.48	4.030	1.235
22	1-1/16	6175	5675	4775	46	1.690	3.52	1.370	1.840	3.63	1.510	30.5	2.190	3.96	1.830	.068
	1-1/4	5650	5175	4450	64	1.850	4.46	1.445	2.015	4.57	1.600	33.2	2.345	4.84	1.905	.094
	1-1/2	4975	4575	4025	92	2.105	5.94	1.565	2.290	6.11	1.735	37.4	2.600	6.33	2.025	.135
	1-3/4	4350	4000	3600	126	2.400	7.70	1.700	2.610	7.87	1.895	42.3	2.900	8.14	2.160	.185
	2	3800	3500	3225	164	2.745	9.74	1.860	2.985	9.96	2.080	48.2	3.245	10.18	2.320	.241
	2-1/4	3325	3075	2875	208	3.135	12.05	2.040	3.405	12.27	2.290	54.4	3.635	12.49	2.500	.306
22	2-1/2	2925	2700	2575	256	3.575	14.63	2.245	3.885	14.91	2.530	63.0	4.070	15.02	2.705	.375
	2-3/4	2575	2375	2300	310	4.055	17.49	2.465	4.400	17.77	2.785	69.7	4.555	17.93	2.925	.456
	3-3/4	1625	1500	1500	577	6.445	31.63	3.570					6.940	32.01	4.030	.848

To figure the Polished Rod Load, Peak Torque and Counterbalance required for a well, select the values shown for the length stroke, size pump and size rods to be used and multiply by the number of feet of depth.  
 EXAMPLE--2600 ft. well using 3/4" Rods, 1-3/4" Pump to be pumped on 42" Stroke.  
 PRL - 3,100 x 2600 = 8060 Polished Rod Load  
 PT - 19.74 x 2600 = 51,324 In. Lbs. Peak Torque  
 CB - 2,160 x 2600 = 5616 Lbs. Effective Counterbalance.

To determine production or horsepower requirements for speeds other than 20 SPM, divide the values obtained from the tables by 20 and multiply by the number of strokes per minute required.  
 EXAMPLE--Unit to be operated at 15 SPM instead of 20 SPM.  
 Production at 20 SPM - 240 Barrels per day  
 Production at 15 SPM = 240 ÷ 20 x 15 = 180 Barrels per day.  
 Horsepower at 20 SPM - 9.2  
 Horsepower at 15 SPM = 9.2 ÷ 20 x 15 = 6.9 HP

PRL - Polished Rod Load, lbs. per ft. of depth.  
 PT - Peak Torque, inch lbs. per ft. of depth.  
 CB - Effective Counterbalance, lbs. per ft. of depth.  
 Depths are based on Pumping Unit capacity and sucker rod stress has been disregarded.  
 All calculations are based on 20 SPM and Specific Gravity of 1.0  
 Production values are based on 80% pump efficiency, rod and tubing stretch and overtravel. have been neglected.

**SPECIFICATIONS  
FOR**

**A-12CF-80 UNIT**

**ALTEN PUMPING UNIT**

**STRUCTURE**

Unit Structure Rating, A.P.I. ....	11,600 lbs.
Range of Strokes .....	28", 38", 48"
Well Working Center .....	72"
Well Clearance with Horsehead Tipped for Servicing .....	22 1/4"
Walking Beam Section and Weight .....	18"
	Wide Flange 50 lbs.
	12'8 3/4"
Height to Top of Walking Beam Above Top of Foundation .....	10'11"
Height of Saddle Bearing Above Top of Foundation .....	18'0"
Overall Length of Base .....	4'7 7/8"
Width of Base at Samson Post .....	Wide Flange
Section and Weight of Main Base Members .....	10" - 21 lbs.
	3" Std. Pipe
Section of Pitman .....	30,000 Hrs. Min. Life
Wrist Pin Roller Bearings Self Aligning .....	Bronze Bushed
Saddle and Equalizer Bearings .....	44 Sq. In.
Saddle Bearing Projected Area .....	28 Sq. In.
Equalizer Bearing Projected Area .....	1,055 lbs. each
Weight of Twin Cranks .....	675 lbs. each
Weight of #3 Crank Weights .....	3/4" (6 x 37)
Polished Rod Hanger Cable .....	1" x 18"
Foundation Bolts .....	5'1 3/4"
Distance from Bottom of Polished Rod Clamp to Top of Foundation at Bottom of Stroke .....	10,975 lbs.
Total Weight of Unit with #3 Weights .....	6,580 lbs.
Maximum Counterweight Effect at Maximum Polished Rod Stroke (with #3 weights)	

**GEAR REDUCER**

Peak Torque Rating, A.P.I. ....	80,000 in. lbs.
Nominal Horsepower Rating (at 20 S.P.M.) .....	16
Reduction Ratio (Double Reduction) .....	30.5:1
Weight of Complete Reducer (less Oil) .....	2250 lbs.
Bearings, Tapered Roller .....	30,000 Hrs. Min. Life
Sheave Section .....	4 Groove C
Sheave Pitch Diameter .....	20.10"
Oil Capacity .....	14 Gallons
Service Brake .....	Automotive Type

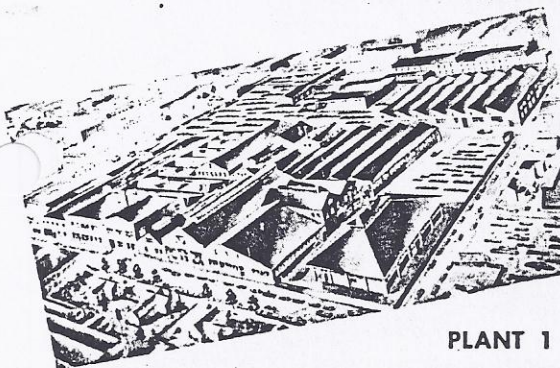

PLANT 1

**ALTEN**

**FOUNDRY & MACHINE WORKS INC.  
LANCASTER, OHIO**

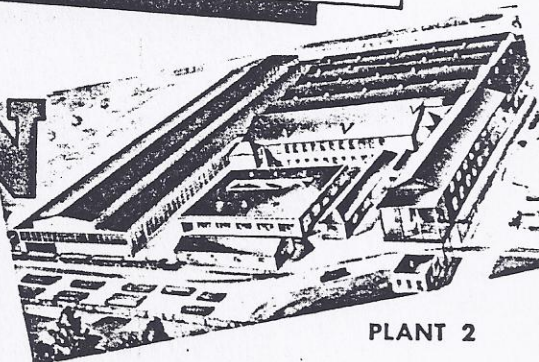

PLANT 2

**Counterbalance Tables**  
**A-10CF-57 Pumping Unit**

**No. 2 CRANKWEIGHTS (STANDARD)**

Position of Weights	Total Counterbalance Effect at Polished Rod (Lbs.)		
	22" Stroke	32" Stroke	42" Stroke
Minimum	4,645	3,245	2,560
2	5,290	3,690	2,900
4	6,310	4,390	3,435
6	7,330	5,090	3,970
8	8,350	5,795	4,505
10	9,370	6,495	5,035
12	10,390	7,195	5,570
14	11,410	7,895	6,105

**No. 3 CRANKWEIGHTS**

Position Of Weights	Total Counterbalance Effect At Polished Rod (Lbs.)		
	22" Stroke	32" Stroke	42" Stroke
Minimum	4,900	3,420	2,695
2	4,900	3,420	2,695
4	6,455	4,490	3,510
6	8,010	5,555	4,325
8	9,565	6,625	5,140
10	11,120	7,695	5,950
12	12,675	8,765	6,765
14	14,230	9,830	7,580

**No. 4 CRANKWEIGHTS**

Position Of Weights	Total Counterbalance Effect At Polished Rod (Lbs.)		
	22" Stroke	32" Stroke	42" Stroke
Minimum	5,865	4,080	3,200
4	6,235	4,335	3,395
6	8,455	5,865	4,555
8	10,675	7,390	5,720
10	12,900	8,920	6,885
12	15,120	10,445	8,050
14	17,340	11,970	9,215

Use Application Table to determine amount of Effective Counterbalance required.

A-12CF-80 UNIT APPLICATION TABLE

11,600 lb. Polished Rod Capacity

80,000 in. lb. Torque

STROKE INCHES	PUMP SIZE	MAX. WELL DEPTH, FT.		BARREL Per 24 HRS.	WELL CALCULATION FACTORS						HP Per 100 FT.					
		5/8	3/4		5/8 Rods PRL	5/8 Rods PT	CB	5/8-3/4 Rods PRL	5/8-3/4 Rods PT	CB		3/4 Rods PRL	3/4 Rods PT	CB		
48	1-1/16	6300	4875	101	1.840	11.28	1.370	2.005	11.88	1.510	30.5	2.385	13.32	1.830	.149	
	1-1/4	5750	4550	140	2.015	13.68	1.445	2.195	14.28	1.600	33.2	2.555	15.60	1.905	.206	
	1-1/2	4600	4100	201	2.290	17.40	1.565	2.490	18.12	1.735	37.4	2.835	19.44	2.025	.396	
	2	3650	3325	274	2.615	21.96	1.700	2.840	22.68	1.895	42.3	3.130	24.00	2.160	.404	
	2-1/4	2950	2750	358	2.990	27.12	1.860	3.255	28.20	2.080	48.2	3.535	29.16	2.320	.527	
	3-3/4	1700	1650	677	4.420	46.92	2.465	4.800	48.36	2.785	69.7	4.960	48.84	2.925	.997	
	3-3/4	975	950	1260	7.025	82.92	3.570	7.230	84.84	4.030	1.850	7.565	84.84	4.030	1.850	
	38	1-1/16	6500	5025	80	1.785	7.89	1.370	1.945	8.27	1.510	30.5	2.310	9.12	1.830	.118
		1-1/4	5950	4675	111	1.950	9.60	1.445	2.125	9.98	1.600	33.2	2.475	10.83	1.905	.164
		1-1/2	5225	4225	159	2.220	12.45	1.565	2.415	12.92	1.735	37.4	2.745	13.68	2.025	.234
		2	4575	3800	217	2.535	15.87	1.700	2.755	16.34	1.895	42.3	3.060	17.10	2.160	.320
		2-1/4	4000	3375	283	2.900	19.76	1.860	3.150	20.33	2.080	48.2	3.425	21.00	2.320	.417
3-3/4		1300	1275	997	6.805	61.47	3.570	7.230	62.70	4.030	1.850	7.565	62.70	4.030	1.850	
28		1-1/16	6725	5200	59	1.725	4.97	1.370	1.880	5.18	1.510	30.5	2.285	5.67	1.830	.087
		1-1/4	6125	4875	82	1.890	6.23	1.445	2.060	6.44	1.600	33.2	2.380	6.86	1.905	.121
		1-1/2	5400	4350	117	2.145	8.12	1.565	2.340	8.47	1.735	37.4	2.665	8.82	2.025	.172
		2	4725	3925	160	2.450	10.50	1.700	2.665	10.78	1.895	42.3	2.960	11.20	2.160	.236
		2-1/4	4125	3500	209	2.805	13.23	1.860	3.050	13.58	2.080	48.2	3.310	13.86	2.320	.308
		3-3/4	1775	1625	735	6.580	42.14	3.570	7.090	42.84	4.030	1.850	7.565	42.84	4.030	1.850

To figure the Polished Rod Load, Peak Torque and Counterbalance required for a well, select the values shown for the length stroke, size pump and size rods to be used and multiply by the number of feet of depth.  
 EXAMPLE--3000 ft. well using 3/4" Rods, 1-3/4" Pump to be pumped on 48" Stroke.  
 PRL - 3.160 x 3000 = 9480 Polished Rod Load  
 PT - 24.00 x 3000 = 72,000 In. Lbs. Peak Torque  
 CB - 2.160 x 3000 = 6480 Lbs. Effective Counterbalance.

To determine production or horsepower requirements for speeds other than 20 SPM, divide the values obtained from the tables by 20 and multiply by the number of strokes per minute required.  
 EXAMPLE--Unit to be operated at 15 SPM instead of 20 SPM.  
 Production at 20 SPM - 274 Barrels per day  
 Production at 15 SPM = 274 ÷ 20 x 15 = 205.5 Barrels per day.  
 Horsepower at 20 SPM - 12  
 Horsepower at 15 SPM = 12 ÷ 20 x 15 = 9 HP

PRL - Polished Rod Load, lbs. per ft. of depth.  
 PT - Peak Torque, inch lbs. per ft. of depth.  
 CB - Effective Counterbalance, lbs. per ft. of depth.  
 Depths are based on Pumping Unit capacity and sucker rod stress has been disregarded.  
 All calculations are based on 20 SPM and Specific Gravity of 1.0.  
 Production values are based on 80% pump efficiency, rod and tubing stretch and overtravel have been neglected.

Counterbalance Tables  
A-12CF-80 Pumping Unit

NO. 3 CRANKWEIGHTS (STANDARD)

Position of Weights	Total Counterbalance Effect at Polished Rod (Lbs.)		
	28" Stroke	38" Stroke	48" Stroke
Minimum	3,745	2,835	2,300
2	3,745	2,835	2,300
4	4,965	3,735	3,015
6	6,190	4,635	3,725
8	7,410	5,535	4,440
10	8,630	6,435	5,150
12	9,855	7,335	5,860
14	11,075	8,235	6,580

NO. 2 CRANKWEIGHTS

Position Of Weights	Total Counterbalance Effect At Polished Rod (Lbs.)		
	28" Stroke	38" Stroke	48" Stroke
Minimum	3,545	2,685	2,185
2	4,055	3,060	2,480
4	4,855	3,650	2,945
6	5,655	4,240	3,415
8	6,460	4,835	3,880
10	7,260	5,425	4,350
12	8,060	6,015	4,815
14	8,860	6,605	5,290

NO. 4 CRANKWEIGHTS

Position Of Weights	Total Counterbalance Effect At Polished Rod (Lbs.)		
	28" Stroke	38" Stroke	48" Stroke
Minimum	4,500	3,395	2,740
4	4,790	3,605	2,910
6	6,540	4,890	3,930
8	8,285	6,180	4,950
10	10,030	7,465	5,965
12	11,775	8,750	6,985
14	13,520	10,035	8,000

Use Application Table to determine amount of Effective Counterbalance required.

**STRUCTURE**

Unit Structure Rating, A.P.I. ....	16,000 lbs.
Range of Strokes .....	34", 44", 54"
Well Working Center .....	81"
Well Clearance with Horsehead Tipped for Servicing .....	17 3/4"
Walking Beam Section and Weight .....	21"
	Wide Flange 68 lbs.
	14' 7 3/4"
Height to Top of Walking Beam Above Top of Foundation .....	12' 6 1/2"
Height of Saddle Bearing Above Top of Foundation .....	18' 10 1/2"
Overall Length of Base .....	5' 9"
Width of Base at Samson Post .....	Wide Flange
Section and Weight of Main Base Members .....	12" - 27 lbs.
	3" Std. Pipe
	30,000 Hrs. Min. Life
	Bronze Bushed
Section of Pitman .....	60 Sq. In.
Wrist Pin Roller Bearings Self Aligning .....	28 Sq. In.
Saddle and Equalizer Bearings .....	1300 lbs. each
Saddle Bearing Projected Area .....	1060 lbs. each
Equalizer Bearing Projected Area .....	1" (6 x 37)
Weight of Twin Cranks .....	1 1/4" x 18"
Weight of #4 Crank Weights .....	6' 4"
Polished Rod Hanger Cable .....	14,350 lbs.
Foundation Bolts .....	9,260 lbs.
Distance from Bottom of Polished Rod Clamp to Top of Foundation at Bottom of Stroke .....	
Total Weight of Unit with #4 Weights .....	
Maximum Counterweight Effect at Maximum Polished Rod Stroke (with #4 weights)	

**GEAR REDUCER**

Peak Torque Rating, A.P.I. ....	114,000 in. lbs.
Nominal Horsepower Rating (at 20 S.P.M.) .....	23
Reduction Ratio (Double Reduction) .....	30.9:1
Weight of Complete Reducer (less Oil) .....	2400 lbs.
Bearings, Tapered Roller .....	30,000 Hrs. Min. Life
Sheave Section .....	4 Groove C
Sheave Pitch Diameter .....	20.10"
Oil Capacity .....	13 Gallons
Service Brake .....	Automotive Type

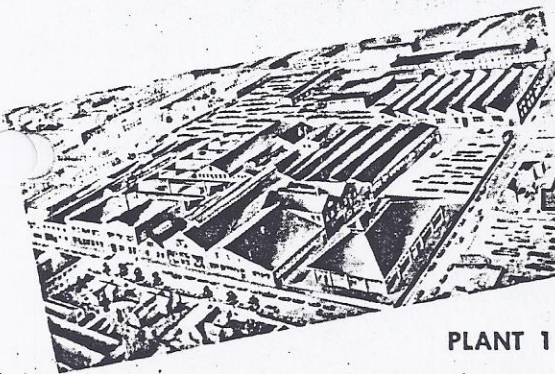

**PLANT 1**

**ALTEN**

**FOUNDRY & MACHINE WORKS INC.  
LANCASTER, OHIO**

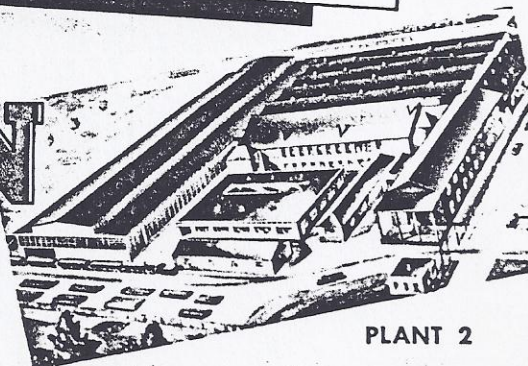

**PLANT 2**



# A-16CF-114 UNIT APPLICATION TABLE

16,000 lb. Polished Rod Capacity

114,000 in. lb. Torque

STROKE INCHES	PUMP SIZE	MAX. WELL DEPTH, FT.		BARREL PER 24 HOURS	WELL CALCULATION FACTORS										HP PER 100 FT.		
		5/8--3/4	3/4		3/4	5/8--3/4	PT	CB	% 3/4 Rods	PRL	3/4 Rods	PT	CB	3/4--7/8		PT	CB
54	1-1/16	7800	6575	6150	114	2.050	14.58	1.510	30.5	2.430	16.20	1.830	2.600	16.88	1.975	25.5	
	1/1/4	6650	6025	5725	157	2.235	17.15	1.600	33.2	2.605	18.90	1.905	2.790	19.71	2.060	27.3	
	1-1/2	5250	4900	4750	226	2.540	21.74	1.735	37.4	2.885	23.22	2.025	3.080	24.03	2.190	29.6	
	1-3/4	4225	4000	3875	308	2.895	27.00	1.895	42.3	3.215	28.49	2.160	3.435	29.43	2.345	32.9	
	2	3425	3300	3200	403	3.315	33.35	2.080	48.2	3.600	34.56	2.320	3.840	35.50	2.525	36.5	
	2-1/4	2825	2750	2675	510	3.780	40.23	2.290	54.4	4.035	41.45	2.500	4.310	42.66	2.730	40.6	
	2-1/2	2375	2325	2275	629	4.300	48.00	2.530	63.0	4.520	49.00	2.705	4.820	50.36	2.955	45.0	
	2-3/4	1975	1975	1925	761	4.910	57.38	2.785	69.7	5.055	57.51	2.925	5.400	59.13	3.210	50.2	
	3-3/4	1150	1150	1125	1417	7.705	99.23	4.030	99.7	7.705	99.23	4.030	8.230	101.93	4.455	75.4	
	44	1-1/16	8075	6800	6350	93	1.980	10.34	1.510	30.5	2.355	11.55	1.830	2.520	12.00	1.975	25.5
		1-1/4	7375	6325	5925	128	2.170	12.54	1.600	33.2	2.525	13.64	1.905	2.700	14.08	2.060	27.3
		1-1/2	6500	5725	5350	184	2.465	16.06	1.735	37.4	2.795	16.94	2.025	2.990	17.60	2.190	29.6
1-3/4		5675	5125	4800	251	2.810	20.13	1.895	42.3	3.120	21.12	2.160	3.330	21.85	2.345	32.9	
2		4575	4425	4300	328	3.210	24.86	2.080	48.2	3.490	25.74	2.320	3.725	26.40	2.525	36.5	
2-1/4		3775	3675	3575	415	3.665	30.25	2.290	54.4	3.910	31.02	2.500	4.175	31.79	2.730	40.6	
2-1/2		3150	3100	3025	513	4.180	36.30	2.530	63.0	4.380	36.85	2.705	4.670	37.73	2.955	45.0	
2-3/4		2650	2625	2575	620	4.735	42.90	2.785	69.7	4.900	43.45	2.925	5.225	44.33	3.210	50.2	
3-3/4		1500	1500	1475	1155	7.470	75.68	4.030	99.7	7.470	75.68	4.030	7.960	77.11	4.455	75.4	
34		1-1/16	8325	7025	6550	72	1.920	6.97	1.510	30.5	2.280	7.65	1.830	2.440	7.91	1.975	25.5
		1-1/4	7625	6550	6125	99	2.100	8.50	1.600	33.2	2.445	9.18	1.905	2.615	9.44	2.060	27.3
		1-1/2	6700	5900	5525	143	2.385	11.05	1.785	37.4	2.710	11.65	2.025	2.895	12.00	2.190	29.6
	1-3/4	5875	5300	4950	194	2.720	14.03	1.895	42.3	3.020	14.62	2.160	3.225	14.96	2.345	32.9	
	2	5150	4725	4425	254	3.110	17.51	2.080	48.2	3.380	18.02	2.320	3.610	18.45	2.525	36.5	
	2-1/4	4500	4250	3950	321	3.550	21.42	2.290	54.4	3.755	21.35	2.500	4.045	22.36	2.730	40.6	
	2-1/2	3950	3775	3525	396	4.045	25.76	2.530	63.0	4.240	26.10	2.705	4.525	26.69	2.955	45.0	
	2-3/4	3500	3375	3175	479	4.585	30.60	2.785	69.7	4.745	30.94	2.925	5.060	31.45	3.210	50.2	
	3-3/4	2225	2225	2075	892	7.230	54.40	4.030	99.7	7.230	54.40	4.030	7.710	55.34	4.455	75.4	

To figure the Polished Rod Load, Peak Torque and Counterbalance required for a well, select the values shown for the length stroke, size pump and size rods to be used and multiply by the number of feet of depth.  
 EXAMPLE--4000 ft. well using 3/4" rods, 1-3/4" Pump to be pumped on 54" stroke.

PRL - 3.215 x 4000 = 12,860 Polished Rod Load  
 PT - 28.49 x 4000 = 113,960 In. Lbs. Peak Torque  
 CB - 2.160 x 4000 = 8640 Lbs. Effective Counterbalance

To determine production or horsepower requirements for speeds other than 20 SPM, divide the values obtained from the tables by 20 and multiply by the number of strokes per minute required.  
 EXAMPLE--Unit to be operated at 15 SPM instead of 20 SPM.  
 Production at 20 SPM - 308 Barrels per day  
 Production at 15 SPM = 308 ÷ 20 x 15 = 231 Barrels per day.  
 Horsepower at 20 SPM - 18

PRL - Polished Rod Load, lbs. per ft. of depth.  
 PT - Peak Torque, Inch lbs. per ft. of depth.  
 CB - Effective Counterbalance, lbs. per ft. of depth.  
 Depths are based on Pumping Unit capacity and sucker rod stresses are based on disregarded.  
 All calculations are based on 20 SPM and Specific Gravity of 1.0.  
 Production values are based on 80% pump efficiency, rod and tubing stretch and overtravel have been neglected.

Counterbalance Tables  
A-16CF-114 Pumping Unit

NO. 4 CRANK WEIGHTS (STANDARD)

Position of Weights	Total Counterbalance Effect at Polished Rod (Lbs.)			
	24" Stroke	34" Stroke	44" Stroke	54" Stroke
Minimum	7,075	5,120	4,045	3,375
4	8,435	6,075	4,785	3,980
6	10,810	7,750	6,080	5,035
8	13,185	9,430	7,380	6,090
10	15,560	11,105	8,675	7,145
12	17,935	12,780	9,970	8,205
14	20,310	14,460	11,265	9,260

NO. 3 CRANK WEIGHTS

Position of Weights	Total Counterbalance Effect at Polished Rod (Lbs.)			
	24" Stroke	34" Stroke	44" Stroke	54" Stroke
Minimum	6,195	4,495	3,565	2,985
2	6,670	4,830	3,825	3,195
4	8,335	6,005	4,730	3,935
6	9,995	7,175	5,635	4,675
8	11,660	8,350	6,545	5,415
10	13,320	9,525	7,450	6,155
12	14,985	10,695	8,355	6,890
14	16,645	11,870	9,265	7,630

NO. 5 CRANK WEIGHTS

Position of Weights	Total Counterbalance Effect at Polished Rod (lbs.)			
	24" Stroke	34" Stroke	44" Stroke	54" Stroke
Minimum	8,045	5,800	4,575	3,805
6	11,045	7,920	6,210	5,140
8	14,545	10,390	8,120	6,695
10	18,045	12,860	10,030	8,250
12	21,545	15,330	11,935	9,805
14	25,045	17,800	13,845	11,360

Use Application Table to determine amount of Effective Counterbalance required.

**SPECIFICATIONS  
FOR**

**A-21CF-160 UNIT**

**ALTEN PUMPING UNIT**

**STRUCTURE**

Unit Structure Rating, A.P.I. ....	20,800 lbs.
Range of Strokes .....	34", 44", 54", 64"
Well Working Center .....	96"
Well Clearance with Horsehead Tipped for Servicing .....	23 3/4"
Walking Beam Section and Weight .....	24"
	Wide Flange 94 lbs.
	16'4"
Height to Top of Walking Beam Above Top of Foundation .....	13'11"
Height of Saddle Bearing Above Top of Foundation .....	21'10 3/4"
Overall Length of Base .....	5'10"
Width of Base at Samson Post .....	Wide Flange
Section and Weight of Main Base Members .....	27 lbs.
	3" Std. Pipe
Section of Pitman .....	30,000 Hrs. Min. Life
Wrist Pin Roller Bearings Self Aligning .....	Bronze Bushed
Saddle and Equalizer Bearings .....	96 Sq. In.
Saddle Bearing Projected Area .....	59 1/2 Sq. In.
Equalizer Bearing Projected Area .....	1770 lbs. each
Weight of Twin Cranks .....	1500 lbs. each
Weight of #5 Crank Weights .....	1" (6 x 37)
Polished Rod Hanger Cable .....	1 1/4" x 18"
Foundation Bolts .....	7'2 1/8"
Distance from Bottom of Polished Rod Clamp to Top of Foundation at Bottom of Stroke .....	20,620 lbs.
Total Weight of Unit with #5 Weights .....	12,530 lbs.
Maximum Counterweight Effect at Maximum Polished Rod Stroke (with #5 weights)	

**GEAR REDUCER**

Peak Torque Rating, A.P.I. ....	160,000 in. lbs.
Nominal Horsepower Rating (at 20 S.P.M.) .....	32.3
Reduction Ratio (Double Reduction) .....	30.2:1
Bearings, Tapered Roller .....	30,000 Hrs. Min. Life
Sheave Section .....	5 Groove C
Sheave Pitch Diameter .....	24"
Oil Capacity .....	15 Gallons
Service Brake .....	Automotive Type

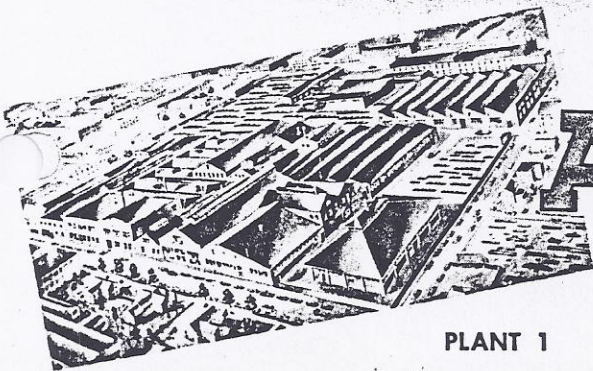

**PLANT 1**

**ALTEN**

**FOUNDRY & MACHINE WORKS INC.  
LANCASTER, OHIO**

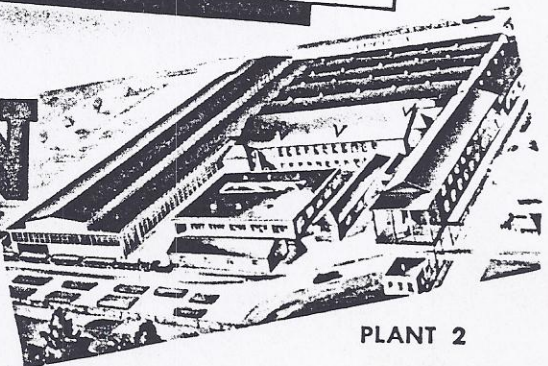

**PLANT 2**

# A - 21CF - 160 UNIT APPLICATION TABLE

20,800 Lb. Polished Rod Capacity

160,000 in. lb. Torque

STROKE INCHES	PUMP SIZE	MAX. WELL DEPTH, FT.		BARREL PER 24 HOURS	WELL CALCULATION FACTORS						HP Per 100 Ft.				
		3/4	7/8		3/4 Rods		3/4--7/8 Rods		7/8 Rods						
		3/4	7/8		PRL	PT	CB	PRL	PT	CB	% 7/8 Rods	PRL	PT	CB	
64	1-1/16	7400	6175	135	2.505	21.60	1.830	2.680	22.56	1.975	25.5	3.200	25.92	2.390	.198
	1-1/4	6400	5475	186	2.685	24.96	1.905	2.875	26.08	2.060	27.3	3.380	29.28	2.465	.273
	1-1/2	5275	4600	268	2.975	30.40	2.025	3.175	31.52	2.190	29.6	3.670	34.72	2.585	.394
	1-3/4	4325	3875	366	3.315	36.96	2.160	3.540	38.24	2.345	32.9	4.010	41.28	2.720	.538
	2	3600	3300	477	3.710	44.48	2.320	3.960	45.92	2.525	36.5	4.400	48.64	2.880	.701
	2-1/4	3025	2800	604	4.160	53.12	2.500	4.440	54.72	2.730	40.6	4.850	57.28	3.060	.888
54	2-1/2	2575	2400	746	4.655	62.40	2.705	4.960	64.16	2.955	45.0	5.340	66.40	3.265	1.097
	2-3/4	2175	2050	902	5.210	73.12	2.925	5.560	75.20	3.210	50.2	5.920	77.92	3.485	1.326
	3-3/4	1275	1225	1680	7.945	125.28	4.030	8.480	128.80	4.455	75.4	8.650	129.92	4.590	2.470
	1-1/16	8550	6700	114	2.430	16.20	1.830	2.600	16.88	1.975	25.5	3.105	19.31	2.390	.168
	1-1/4	7975	6350	157	2.605	18.90	1.905	2.790	19.71	2.060	27.3	3.280	22.00	2.465	.231
	1-1/2	6900	5850	226	2.885	23.22	2.025	3.080	24.03	2.190	29.6	3.560	26.33	2.585	.332
44	1-3/4	5625	5075	308	3.215	28.49	2.160	3.435	29.43	2.345	32.9	3.890	31.59	2.720	.453
	2	4625	4275	403	3.600	34.56	2.320	3.840	35.50	2.525	36.5	4.270	37.53	2.880	.592
	2-1/4	3850	3600	510	4.035	41.45	2.500	4.310	42.66	2.730	40.6	4.710	44.55	3.060	.750
	2-1/2	3275	3100	629	4.520	49.00	2.705	4.820	50.36	2.955	45.0	5.180	51.71	3.265	.925
	2-3/4	2775	2625	761	5.055	57.51	2.925	5.400	59.13	3.210	50.2	5.740	60.89	3.485	1.189
	3-3/4	1600	1550	1417	7.705	99.23	4.030	8.230	101.93	4.455	75.4	8.390	102.60	4.590	2.083
44	1-1/16	8825	6900	93	2.355	11.55	1.830	2.520	12.00	1.975	25.5	3.010	13.64	2.390	.137
	1-1/4	8250	6550	128	2.525	13.64	1.905	2.700	14.08	2.060	27.3	3.180	15.73	2.465	.188
	1-1/2	7450	6025	184	2.795	16.94	2.025	2.990	17.60	2.190	29.6	3.450	19.03	2.585	.270
	1-3/4	6675	5525	251	3.120	21.12	2.160	3.330	21.85	2.345	32.9	3.770	23.10	2.720	.369
	2	5950	5025	328	3.490	25.74	2.320	3.720	26.40	2.525	36.5	4.140	27.72	2.880	.482
	2-1/4	5150	4550	415	3.910	31.02	2.500	4.175	31.79	2.730	40.6	4.560	33.00	3.060	.610
44	2-1/2	4350	4150	513	4.380	36.85	2.705	4.670	37.73	2.955	45.0	5.085	38.72	3.265	.754
	2-3/4	3675	3500	620	4.900	43.45	2.925	5.225	44.33	3.210	50.2	5.560	45.65	3.485	.911
	3-3/4	2125	2050	1155	7.470	75.68	4.030	7.960	77.11	4.455	75.4	8.140	78.10	4.590	1.698

To figure the Polished Rod Load, Peak Torque and Counterbalance required for a well, select the values shown for the length stroke, size pump and size rods to be used and multiply by the number of feet of depth.  
**EXAMPLE** - 2700 ft. well using 7/8" rods, 2-1/4" Pump to be pumped on 64" Stroke.

PRL - 4,850 x 2700 = 13,095 Polished Rod Load  
 PT - 57.28 x 2700 = 154,656 In.-Lbs. Peak Torque  
 CB - 3,060 x 2700 = 8262 Lbs. Effective Counterbalance.

To determine production or horsepower requirements for speeds other than 20SPM, divide the values obtained from the tables by 20 and multiply by the number of strokes per minute required.  
**EXAMPLE** - Unit to be operated at 15 SPM instead of 20 SPM.  
 Production at 20 SPM - 604 Barrels per day  
 Production at 15 SPM = 604 ÷ 20 x 15 = 454 Barrels per day.  
 Horsepower at 20 SPM = 24  
 Horsepower at 15 SPM = 24 ÷ 20 x 15 = 18 HP

PRL - Polished Rod Load, lbs. per ft. of depth.  
 PT - Peak Torque, inch lbs. per ft. of depth.  
 CB - Effective Counterbalance, lbs. per ft. of depth.  
 Depths are based on Pumping Unit capacity and sucker rod stress has been disregarded.  
 All calculations are based on 20 SPM and Specific Gravity of 1.0.  
 Production values are based on 80% pump efficiency, rod and tubing stretch and overtravel have been neglected.

Counterbalance Tables  
A-21CF-160 Pumping Unit

NO. 5 CRANK WEIGHTS (STANDARD)

Position of Weights	Total Counterbalance Effect at Polished Rod (Lbs.)			
	34" Stroke	44" Stroke	54" Stroke	64" Stroke
Minimum	8,025	6,350	5,290	4,555
6	10,850	8,530	7,070	6,055
8	13,850	10,850	8,960	7,645
10	16,850	13,165	10,845	9,240
12	19,850	15,485	12,735	10,835
14	22,850	17,800	14,625	12,430

NO. 4 CRANK WEIGHTS

Position of Weights	Total Counterbalance Effect At Polished Rod (Lbs.)			
	34" Stroke	44" Stroke	54" Stroke	64" Stroke
Minimum	7,345	5,820	4,860	4,190
4	8,420	6,655	5,540	4,765
6	10,455	8,230	6,320	5,845
8	12,490	9,800	8,105	6,930
10	14,530	11,375	9,385	8,010
12	16,565	12,950	10,670	9,090
14	18,600	14,520	11,950	10,175

NO. 6 CRANK WEIGHTS

Position of Weights	Total Counterbalance Effect At Polished Rod (Lbs.)			
	34" Stroke	44" Stroke	54" Stroke	64" Stroke
Minimum	9,545	7,520	6,250	5,360
6	10,955	8,610	7,135	6,110
8	14,955	11,705	9,655	8,235
10	18,955	14,795	12,175	10,360
12	22,955	17,885	14,690	12,485
14	26,955	20,975	17,210	14,610

Use Application Table to determine amount of Effective Counterbalance required.

**SPECIFICATIONS FOR**

**A-24CF-228 UNIT**

**ALTEN PUMPING UNIT**

**STRUCTURE**

Unit Structure Rating, A.P.I. ....	23,700 lbs.
Range of Strokes .....	44", 54", 64", 74"
Well Working Center .....	110"
Well Clearance with Horsehead Tipped for Servicing .....	26 1/2"
Walking Beam Section and Weight .....	24"
	Wide Flange 110 lbs.
	18'4"
Height to Top of Walking Beam Above Top of Foundation .....	15'11"
Height of Saddle Bearing Above Top of Foundation .....	24'0"
Overall Length of Base .....	6'0"
Width of Base at Samson Post .....	Wide Flange
Section and Weight of Main Base Members .....	14" - 30 lbs.
	4" Std. Pipe
Section of Pitman .....	30,000 Hrs. Min. Life
Wrist Pin Roller Bearings Self Aligning .....	Bronze Bushed
Saddle and Equalizer Bearings .....	96 Sq. In.
Saddle Bearing Projected Area .....	59 1/2 Sq. In.
Equalizer Bearing Projected Area .....	2400 lbs. each
Weight of Twin Cranks .....	2000 lbs. each
Weight of #5 Crank Weights .....	1" (6 x 37)
Polished Rod Hanger Cable .....	1 1/4" x 18"
Foundation Bolts .....	7'3"
Distance from Bottom of Polished Rod Clamp to Top of Foundation at Bottom of Stroke	25,120 lbs.
Total Weight of Unit with #5 Weights .....	14,390 lbs.
Maximum Counterweight Effect at Maximum Polished Rod Stroke (with #5 weights)	

**GEAR REDUCER**

Peak Torque Rating, A.P.I. ....	228,000 in. lbs.
Nominal Horsepower Rating (at 20 S.P.M.) .....	46.1
Reduction Ratio (Double Reduction) .....	32.1:1
Bearings, Tapered Roller .....	30,000 Hrs. Min. Life
Sheave Section .....	6 Groove C
Sheave Pitch Diameter .....	24"
Oil Capacity .....	17 Gallons
Service Brake .....	Automotive Type

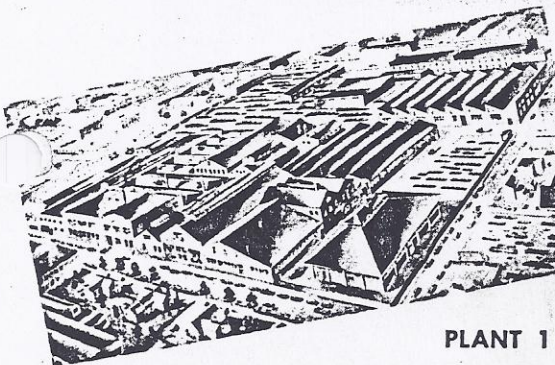

PLANT 1

**ALTEN**

FOUNDRY & MACHINE WORKS INC.  
LANCASTER, OHIO

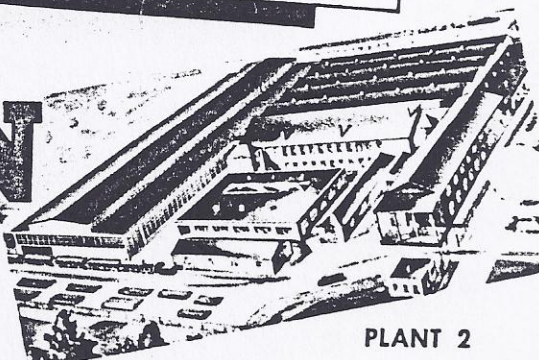

PLANT 2

A - 24CF - 228 UNIT APPLICATION TABLE

23,700 lb. Polished Rod Capacity

228,000 in. lb. Torque

STROKE INCHES	PUMP SIZE	MAX. WELL DEPTH, FT.		BARREL PER 24 HOURS	WELL CALCULATION FACTORS												HP Per 100 Ft.			
		3/4 Rod Size	7/8 Rod Size		3/4 - 7/8 Rods			3/4-7/8-1 Rods			% 7/8 Rods			% 7/8 Rods						
		3/4	7/8		PRL	PT	CB	PRL	PT	CB	PRL	PT	CB	% 7/8 Rods	% 7/8 Rods	% 7/8 Rods	PRL	PT	CB	
74	1-1/16	7850	7325	6800	156	2.760	29.05	1.975	2.995	31.08	2.155	2.995	31.08	2.155	19.5	17.2	3.295	33.49	2.390	.229
	1-1/4	6850	6375	6075	215	2.960	33.30	2.060	3.220	35.71	2.255	3.220	35.71	2.255	21.2	18.7	3.480	37.56	2.465	.316
	1-1/2	5700	5350	5150	310	3.270	39.96	2.190	3.570	42.55	2.420	3.570	42.55	2.420	23.9	21.1	3.780	44.22	2.585	.456
	1-3/4	4750	4475	4375	423	3.645	48.10	2.345	3.985	50.88	2.610	3.985	50.88	2.610	27.0	23.9	4.130	52.17	2.720	.522
	2	3950	3750	3700	552	4.080	57.54	2.525	4.470	60.87	2.825	4.470	60.87	2.825	30.7	27.1	4.540	61.42	2.880	.811
	2-1/4	3325	3175	3175	699	4.580	68.45	2.730	5.025	71.97	3.080	5.025	71.97	3.080	34.8	30.9	5.000	71.78	3.060	1.028
64	2-1/2	2850	2700	2750	862	5.110	79.74	2.985	5.640	84.36	3.360	5.640	84.36	3.360	39.5	35.0	5.500	82.70	3.265	1.267
	2-3/4	2425	2325	2350	1043	5.740	93.61	3.210	6.320	98.24	3.665	6.320	98.24	3.665	44.6	39.5	6.100	96.76	3.485	1.533
	3-3/4	1450	1400	1425	1942	8.740	158.55	4.455	9.250	162.25	4.865	9.250	162.25	4.865	50.2	44.5	8.910	159.84	4.590	2.555
	1-1-16	8725	8050	7325	135	2.680	22.56	1.975	2.905	24.00	2.155	2.905	24.00	2.155	19.5	17.2	3.200	25.92	2.390	.198
	1-1/4	8150	7500	6925	186	2.875	26.08	2.060	3.120	27.68	2.255	3.120	27.68	2.255	21.2	18.7	3.380	29.28	2.465	.273
	1-1/2	7225	6775	6375	268	3.175	31.52	2.190	3.460	33.28	2.420	3.460	33.28	2.420	23.9	21.1	3.670	34.72	2.585	.394
54	1-3/4	5950	5650	5525	366	3.540	38.24	2.345	3.870	40.32	2.610	3.870	40.32	2.610	27.0	23.9	4.010	41.28	2.720	.538
	2	4975	4700	4675	477	3.960	45.92	2.525	4.345	48.64	2.825	4.345	48.64	2.825	30.7	27.1	4.400	48.64	2.880	.701
	2-1/4	4175	3950	3975	604	4.440	54.72	2.730	4.885	57.76	3.080	4.885	57.76	3.080	34.8	30.9	4.850	57.28	3.060	.888
	2-1/2	3550	3375	3425	746	4.960	64.16	2.955	5.470	67.52	3.360	5.470	67.52	3.360	39.5	35.0	5.340	66.40	3.265	1.097
	2-3/4	3025	2875	2925	902	5.560	75.20	3.210	6.140	79.20	3.665	6.140	79.20	3.665	44.6	39.5	5.920	77.92	3.485	1.526
	3-3/4	1775	1725	1750	1679	8.480	128.80	4.455	8.990	132.00	4.865	8.990	132.00	4.865	50.2	44.5	8.650	129.92	4.590	2.468
44	1-1/16	9000	8300	7525	114	2.600	16.88	1.975	2.820	17.96	2.155	2.820	17.96	2.155	19.5	17.2	3.105	19.31	2.390	.168
	1-1/4	8375	7725	7125	157	2.790	19.71	2.060	3.030	20.98	2.255	3.030	20.98	2.255	21.2	18.7	3.280	22.00	2.465	.231
	1-1/2	7600	6975	6575	226	3.080	24.03	2.190	3.360	25.38	2.420	3.360	25.38	2.420	23.9	21.1	3.560	26.33	2.585	.332
	1-3/4	6800	6225	6025	308	3.435	29.43	2.345	3.755	30.92	2.610	3.755	30.92	2.610	27.0	23.9	3.890	31.59	2.720	.453
	2	6100	5550	5475	403	3.840	35.50	2.525	4.210	37.40	2.825	4.210	37.40	2.825	30.7	27.1	4.270	37.53	2.880	.592
	2-1/4	5350	4925	4975	510	4.310	42.66	2.730	4.740	44.82	3.080	4.740	44.82	3.080	34.8	30.9	4.710	44.55	3.060	.750
34	2-1/2	4525	4325	4400	629	4.820	50.36	2.955	5.310	52.65	3.360	5.310	52.65	3.360	39.5	35.0	5.180	51.71	3.265	.925
	2-3/4	3850	3700	3750	761	5.400	59.13	3.210	5.950	61.70	3.665	5.950	61.70	3.665	44.6	39.5	5.740	60.89	3.485	1.119
	3-3/4	2225	2200	2225	1417	8.230	101.93	4.455	8.710	103.82	4.865	8.710	103.82	4.865	50.2	44.5	8.390	102.60	4.590	2.083

To figure the Polished Rod Load, Peak Torque and Counterbalance required for a well, select the values shown for the length stroke, size pump and size rods to be used and multiply by the number of feet of depth.

EXAMPLE - 3000 ft. well using 7/8" rods, 2-1/4" Pump to be pumped on 74" Stroke.

PRL - 5,000 x 3000 = 15,000 Polished Rod Load  
 PT - 71.78 x 3000 = 215,340 In.Lbs. Peak Torque  
 CB - 3.060 x 3000 = 9180 Lbs. Effective Counterbalance.

To determine production or horsepower requirements for speedsother than 20 SPM, divide the values obtained from the tables by 20 and multiply by the number of strokes per minute required.

EXAMPLE-- Unit to be operated at 15 SPM instead of 20 SPM.  
 Production at 20 SPM = 699 Barrels per day.  
 Production at 15 SPM = 699 ÷ 20 x 15 = 524 Barrels per day.  
 Horsepower at 20 SPM = 30.84  
 Horsepower at 15 SPM = 2 ÷ 20 x 15 = 22.13 HP

Depths are based on Pumping Unit capacity and sucker rod stress has been disregarded.  
 All calculations are based on 20 SPM and Specific Gravity of 1.0.  
 Production values are based on 80% pump efficiency, rod and tubing stretch and overtravel have been neglected.

Counterbalance Tables  
A-24CF-228 Pumping Unit

NO. 5 CRANK WEIGHTS (STANDARD)

Position of Weights	Total Counterbalance Effect At Polished Rod (Lbs.)			
	44" Stroke	54" Stroke	64" Stroke	74" Stroke
Minimum	9,385	7,740	6,615	5,790
4	10,200	8,410	7,175	6,275
6	12,930	10,630	9,050	7,900
8	15,655	12,850	10,925	9,520
10	18,385	15,075	12,800	11,140
12	21,110	17,295	14,675	12,765
14	23,835	19,520	16,550	14,390

NO. 4 CRANKWEIGHTS

Position of Weights	Total Counterbalance Effect At Polished Rod (Lbs.)			
	44" Stroke	54" Stroke	64" Stroke	74" Stroke
Minimum	8,855	7,310	6,250	5,475
4	10,340	8,520	7,270	6,360
6	12,190	10,025	8,540	7,455
8	14,040	11,535	9,815	8,560
10	15,890	13,045	11,085	9,660
12	17,740	14,550	12,360	10,760
14	19,590	16,060	13,630	11,860

NO. 6 CRANKWEIGHTS

Position of Weights	Total Counterbalance Effect At Polished Rod (Lbs.)			
	44" Stroke	54" Stroke	64" Stroke	74" Stroke
Minimum	10,555	8,700	7,420	6,490
6	13,465	11,070	9,420	8,215
8	17,100	14,030	11,920	10,380
10	20,735	17,000	14,420	12,540
12	24,375	19,955	16,920	14,700
14	28,010	22,920	19,420	16,865

Use Application Table to determine amount of Effective Counterbalance required.



# ENGINEERING DATA SHEET

**THE S. M. JONES COMPANY**

DIVISION OF BUFFALO-ECLIPSE CORP.

**ENGINEERING DEPT.**

**TOLEDO, OHIO**

**TULSA, OKLA.**



**SUCKER ROD LOADS  
IMPULSE FACTORS  
TAPERED ROD STRINGS  
PUMP EFFICIENCIES (APPARENT VOLUMETRIC)**



## **MILLS SUCKER ROD LOAD FORMULA**

$$P = W_r \left( 1 + \frac{LN^2}{70500} \right) + W_{..}$$

- P = Polished rod load.
- W<sub>..</sub> = Weight of fluid (based on net plunger areas) and 1.00 S. G.
- W<sub>r</sub> = Weight of Rods.
- L = Polished rod Stroke — inches.
- N = Cycles per minute.

Values of W<sub>..</sub> are found in Table 3. Multiply these values by specific gravity if known.

Values of W<sub>r</sub> are found in Table 1.

Acceleration factors for Mills Formula are given in Table 2.

If pumping fluid level is known, use this value in calculating weight of fluid.

Otherwise multiply values in table 3 by depth to pump.

**USING THE DATA HEREIN, SUCKER ROD LOADS  
CAN BE EASILY AND QUICKLY CALCULATED**

## TABLES FOR CALCULATING SUCKER ROD LOADS

### TO FIND POLISHED ROD LOAD—

Multiply Wt. of Rods per foot by length of Rod String × Acceleration Factor, and add Wt. per ft. of Fluid × Depth to Pump × Specific Gravity of Fluid.

**WEIGHT OF RODS PER FOOT**

**TABLE 1**

ROD COMB.	PLUNGER DIAMETER										
	3/4"	1"	1 1/4"	1 1/2"	1 3/4"	2"	2 1/4"	2 1/2"	2 3/4"	3 3/4"	4"
5/8"	1.18	1.18	1.18	1.18	1.18	1.18	1.18	1.18	1.18	1.18	1.18
3/4" x 5/8"	1.30	1.32	1.33	1.35	1.37	1.40	1.43	1.46	1.50		
3/4"	1.64	1.64	1.64	1.64	1.64	1.64	1.64	1.64	1.64	1.64	1.64
7/8" x 3/4" x 5/8"		1.48	1.53	1.59	1.65	1.72	1.82				
7/8" x 3/4"		1.78	1.79	1.80	1.82	1.84	1.87	1.89	1.92	2.06	
7/8"	2.20	2.20	2.20	2.20	2.20	2.20	2.20	2.20	2.20	2.20	2.20
1 x 7/8" x 3/4"		1.94	1.99	2.04	2.09	2.15	2.22	2.30	2.38	2.47	
1" x 7/8"		2.35	2.37	2.38	2.39	2.41	2.43	2.45	2.48	2.59	2.60
1"	2.88	2.88	2.88	2.88	2.88	2.88	2.88	2.88	2.88	2.88	2.88

**(MILLS) ACCELERATION FACTORS  $C = 1 + \frac{LN^2}{70500}$**

**TABLE 2**

STROKE LENGTH	CYCLES PER MINUTE															
	5	10	12	14	15	16	18	20	22	24	25	26	28	30	35	40
24"	1.008	1.034	1.049	1.067	1.076	1.087	1.110	1.136	1.165	1.196	1.213	1.230	1.267	1.306	1.417	1.545
34"	1.012	1.048	1.069	1.094	1.108	1.123	1.156	1.193	1.234	1.278	1.301	1.326	1.378	1.434	1.590	1.772
44"	1.015	1.062	1.090	1.122	1.140	1.160	1.202	1.249	1.302	1.360	1.390	1.422	1.490	1.561	1.764	
54"	1.019	1.076	1.111	1.150	1.172	1.196	1.248	1.306	1.371	1.441	1.479	1.518	1.600	1.689		
64"	1.023	1.090	1.137	1.178	1.204	1.232	1.294	1.363	1.44	1.523	1.567	1.615	1.711	1.817		
74"	1.026	1.104	1.152	1.206	1.236	1.269	1.340	1.42	1.508	1.605	1.656	1.710	1.823	1.944		
84"	1.030	1.119	1.170	1.233	1.268	1.305	1.386	1.476			1.745					
96"	1.034	1.136	1.196	1.264	1.306	1.348	1.441	1.545			1.851					
108"	1.038	1.153	1.219	1.303	1.345	1.392	1.496	1.613								
120"	1.043	1.170	1.245	1.334	1.383	1.435	1.55	1.681								

**WEIGHT OF FLUID PER FOOT .434#/Sq. In./Ft. 1.00 S. G.**

**TABLE 3**

ROD COMB.	PLUNGER DIAMETER										
	3/4"	1"	1 1/4"	1 1/2"	1 3/4"	2"	2 1/4"	2 1/2"	2 3/4"	3 3/4"	4"
5/8"	.056	.204	.399	.634	.912	1.23	1.59	2.00	2.44	4.66	5.32
3/4" x 5/8"	.041	.184	.380	.612	.890	1.20	1.56	1.97	2.42		
3/4"		.147	.343	.577	.855	1.17	1.536	1.94	2.37	4.60	5.26
7/8" x 3/4" x 5/8"		.170	.356	.583	.854	1.16	1.515				
7/8" x 3/4"		.130	.323	.560	.830	1.15	1.51	1.91	2.34	4.55	
7/8"		.078	.274	.507	.785	1.10	1.47	1.87	2.315	4.53	5.19
1" x 7/8" x 3/4"		.109	.297	.535	.802	1.11	1.47	1.86	2.29		
1" x 7/8"		.060	.264	.490	.760	1.06	1.44	1.83	2.27	4.48	5.14
1"			.195	.430	.710	1.03	1.39	1.79	2.24	4.45	5.11

In view of the limited experience with correlation of calculated and measured loads on hydraulic units, Mills acceleration factor is applied to long stroke pumping

**LONG STROKE ACCELERATION FACTOR**  $C = 1 + \frac{LN^2}{70500}$

**TABLE 4**

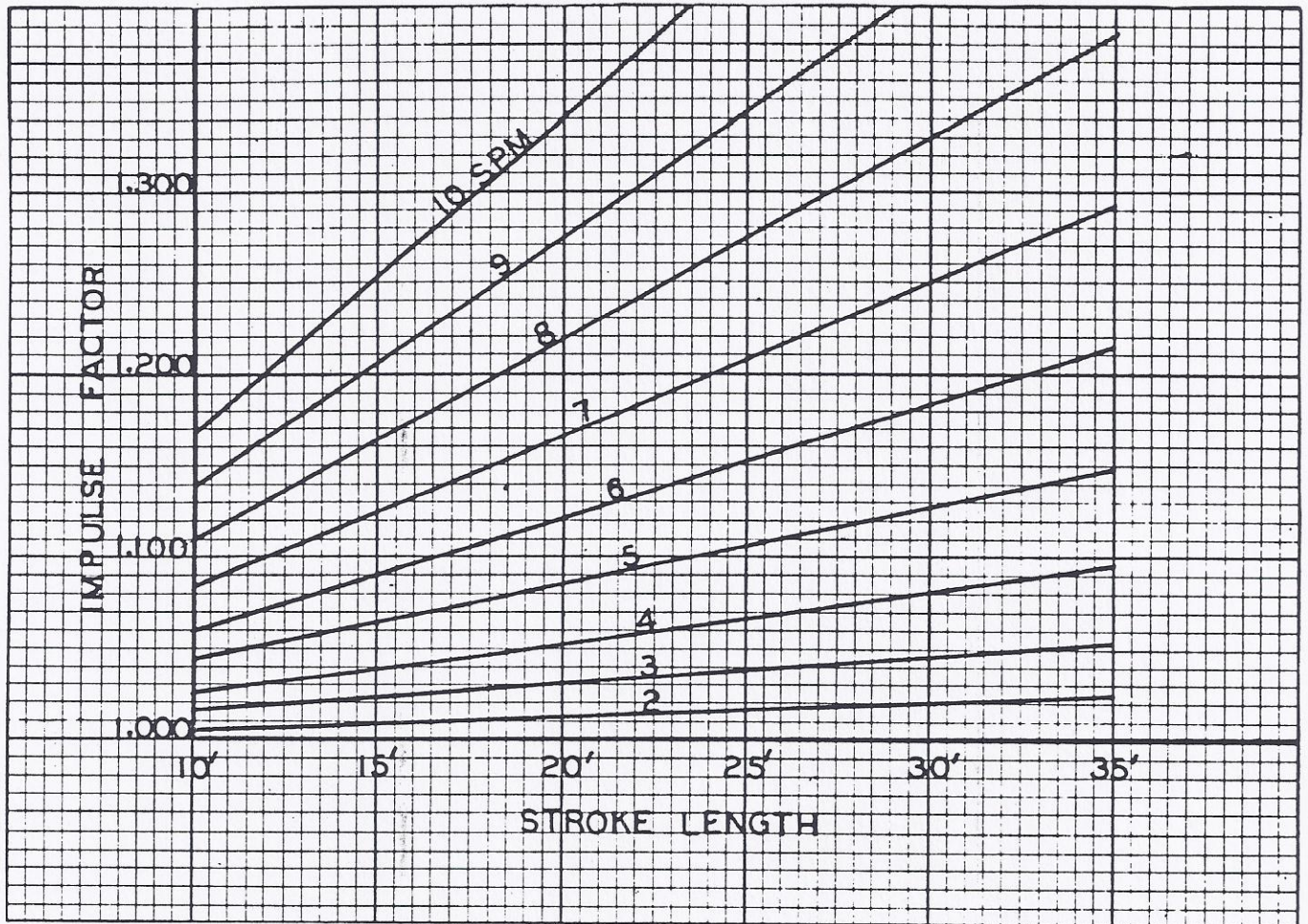

NOTE: Calculations below are based on net plunger area—1.00 S.G. Fluid.

**EQUAL STRESS FOR TOP ROD OF EACH SIZE**

**TABLE 5**

**TAPERED SUCKER ROD STRINGS**

PLUNGER DIAM.	3/4" x 5/8"		7/8" x 3/4" x 5/8"			1" x 7/8"	1" x 7/8" x 3/4"		
	% 3/4"	% 7/8"	%	%	%	% 1"	%	%	%
3/4"	27.0	23.8							
15/16"	28.9	24.6							
1"	29.6	25.0	19.3	23.0	57.7	22.7	16.7	19.0	64.3
1-1/16"	30.5	25.5	20.3	23.4	56.3	23.1	17.2	19.5	63.3
1-1/4"	33.2	27.3	22.6	26.1	51.3	24.3	18.7	21.2	60.1
1-1/2"	37.4	29.6	26.5	30.2	43.3	26.2	21.1	23.9	55.0
1-3/4"	42.3	32.9	30.6	35.2	34.2	28.4	23.9	27.0	49.1
2"	48.2	36.5	35.7	41.0	23.3	30.9	27.1	30.7	42.2
2-1/4"	54.4	40.6	42.0	47.0	11.0	33.8	30.9	34.8	34.3
2-7/16"	59.8	44.0				36.2			
2-1/2"	63.0	45.0				37.0	35.0	39.5	25.5
2-3/4"	69.7	50.2				40.6	39.5	44.6	15.9
3-3/4"		75.4				58.2	44.5	50.2	5.3
4"						58.5			

## TO FIND APPARENT VOLUMETRIC EFFICIENCY

Divide actual production by theoretical production. Theoretical production = speed in strokes per minute × length of stroke in inches × "pump constant" as in table shown below. (Table 6)

**TABLE 6**

FULL AND NET PLUNGER AREAS WITH ALL SIZES OF SUCKER RODS — SQ. IN.															
ROD DIAM.	ROD AREA	PLUNGER DIAMETER													
		¾"	⅞"	1"	1⅛"	1¼"	1½"	1¾"	2"	2¼"	2⅝"	2½"	2¾"	3¾"	4"
⅝"	.31	.13	.38	.46	.57	.92	1.46	2.10	2.83	3.67	4.35	4.60	5.63	10.73	12.25
¾"	.44	.00	.25	.34	.44	.79	1.33	1.97	2.70	3.54	4.22	4.47	5.50	10.60	12.12
⅞"	.60	.00	.09	.18	.28	.63	1.17	1.81	2.54	3.38	4.06	4.31	5.34	10.44	11.96
1"	.78	.00	.00	.00	.10	.45	.99	1.63	2.36	3.20	3.88	4.13	5.16	10.26	11.78
1⅛"	.99	.00	.00	.00	.00	.24	.78	1.42	2.15	2.99	3.68	3.92	4.95	10.05	11.57
Full Plunger		.44	.69	.78	.88	1.23	1.77	2.41	3.14	3.98	4.66	4.91	5.94	11.04	12.56
Pump Constant		.065	.095	.117	.132	.182	.262	.357	.466	.590	.692	.728	.881	1.64	1.86

## WORKING LOADS JonesSuckerRods

For best economical service, rod loads should be kept below the following figures for size and type:

Rod	Working Loads in Pounds for Each Rod Size <i>NM</i>			
	Type 2	Type 1	Type 7	Type 12
⅝"	6,730	9,300	10,170	13,600
¾"	9,700	13,300	14,620	19,400
⅞"	13,170	18,500	19,900	26,400
1"	17,200	23,600	26,000	34,300

**THE S. M. JONES COMPANY**  
ENGINEERING DEPARTMENT

# ALTEN UNDERPULL PUMPING JACKS

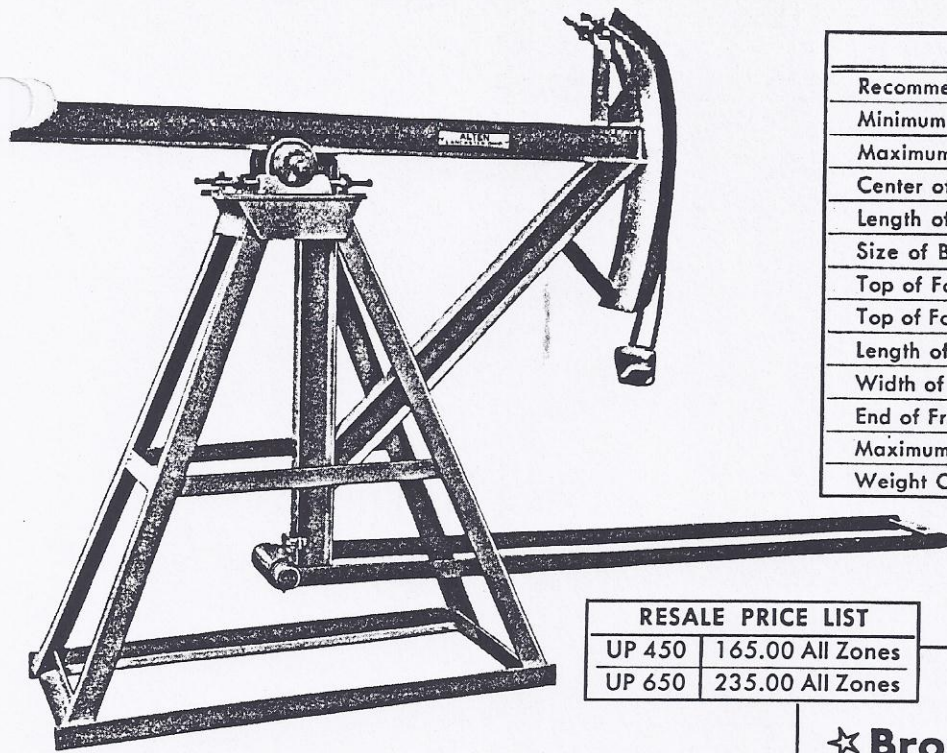

SPECIFICATIONS	UP 450	UP 650
Recommended Polished Rod Load	4500#	6500#
Minimum Ratio	1.10:1	1. 1:1
Maximum Ratio	1.55:1	1.43:1
Center of Well to Saddle	42"	48"
Length of Beam	70"	80"
Size of Beam	5"	5"
Top of Foundation to Center of Saddle	55"	60"
Top of Foundation to Hangar at Mid-Stroke	32"	33"
Length of Base	56"	60"
Width of Base	24"	27½"
End of Frame to Center of Well	14"	18"
Maximum Stroke	26"	30"
Weight Complete	400#	595#

RESALE PRICE LIST	
UP 450	165.00 All Zones
UP 650	235.00 All Zones

Alten designed for long life and maximum service. All welded steel construction provides greater strength and rigidity. Grooved bronze bearings carry lubrication along the entire length. Oil seals make all bearings dust proof and leak proof. Set screws at saddle bearings permit sure adjustment of horsehead. Alten underpull jacks are constructed to allow a wide range of strokes.

- ☆ Bronze Bearings
- ☆ Adjustable Horsehead
- ☆ Wide Range of Strokes

## PARTS LIST

DESCRIPTION	Up 450		Up 650	
	Pcs. Per Unit	Catalog No.	Pcs. Per Unit	Catalog No.
Beam and "V" Frame Assembly.....	1	45U-4	1	65U-9
Polished Rod Hanger Assembly.....	1	45U-15	1	65U-29
Polished Rod Hanger.....	1	5-38	1	8-64
Wire Rope.....	1	PP-542	1	PP-118
Wire Rope Clamp Cap.....	2	16031	..	.....
Wedge.....	..	.....	2	8-78
Polished Rod Hanger Gate.....	1	5-39	1	8-57
Pull Bar Reins.....	1	45U-5	1	65U-16
Pull Bar Bearing Assembly.....	1	45U-6	1	65U-20
Bearing Housing.....	1	45U-7	1	65U-22
Bearing Shaft.....	1	45U-8	1	65U-21
Bronze Bushing.....	2	45U-9	2	4-35
Oil Seal.....	2	PP-488	2	PP-347
Frame Assembly.....	1	45U-3	1	65U-3
Saddle Bearing Assembly.....	1	45U-10	1	65U-23
Saddle Bearing Housing.....	2	4-32	2	5-15
Saddle Bearing Base Block.....	2	4-31	2	5-19
Bronze Bushing.....	2	4-35	2	5-16
Oil Seal.....	2	PP-347	2	PP-393
Saddle Shaft.....	1	45U-11	1	65U-24
Saddle Base Adjusting Screw.....	4	PP-532	4	PP-528
Pull Bar Shaft w/cotter pin.....	2	45U-14	2	65U-27
Pull Bar Bearing Bolt—½"x 2" square head w/hex nut, l.w. and tapered washer.....	2	.....	..	.....
Pull Bar Bearing Bolt—⅝"x 2¼" square head w/hex nut, l.w. and tapered washer.....	..	.....	2	.....
Wire Rope Clamp Cap Bolt—½"x 2¼" square head w/hex nut and lock washer.....	4	.....	..	.....
Saddle Bearing "U" Bolt.....	2	4-40	2	5-20
Saddle Shaft "U" Bolt.....	2	45U-12	2	65U-25
Saddle Shaft Adjusting Screw—¾"x 2" square hd. cup pt. w/hex jam nut.....	2	.....	..	.....
Saddle Shaft Adjusting Screw—1"x 2½" square hd. cup pt. w/hex jam nut.....	..	.....	2	.....

# INSTALLATION AND MAINTENANCE INSTRUCTIONS

## for ALTEN Pumping Units

ALTEN Pumping Units are designed to give long trouble-free service, if operated within rated capacity and properly installed and serviced. Correct counterbalancing and maintenance are two important requirements for maximum pumping unit, prime mover, and belt life.

BEFORE PLACING UNIT IN OPERATION THE FOLLOWING PRECAUTIONS SHOULD BE TAKEN:

- (1) Make certain unit is level, etc. (See section on Installation of Unit).
- (2) Fill Gear Reducer with oil to oil level indicated on gauge. (See section on Lubrication of Gear Reducer for type oil).
- (3) Lubricate all Bearings. (See section on Lubrication of Bearings).
- (4) Tighten all Bolts. This should include Foundation Bolts and Wrist Pin Nuts.
- (5) Adjust Brake.
- (6) Check clearance of Cranks and Weights with Foundation and V-Belt Guard.
- (7) Adjust V-Belts to proper tightness. (See section on Engine and V-Belt Adjustment).
- (8) Adjust Counterbalance weights to estimated counterbalance.

AFTER 24 HOURS OPERATION THE FOLLOWING SHOULD BE CHECKED:

- (1) Tightness of all bolts.
- (2) Tightness of wrist pin nuts.
- (3) Reducer oil level.
- (4) Adjust counterbalance if required.

### FOUNDATION

A concrete foundation is recommended because of its rigidity and permanency. Good results are often obtained, however, on semi-permanent locations, with heavy wooden timbers properly spaced and supported. An anchor bolt layout drawing is furnished with each unit for installation purposes. The actual depth and width of the foundation is dependent upon the soil conditions existing at the location. It is a must that the concrete foundation extend below the frost line to give satisfactory service.

To make the installation of the unit over the foundation bolts easier, it is well to place a piece of pipe around the foundation bolt, so as to be flush with the top of the foundation. This will allow the bolt to be adjusted, to compensate for slight errors in layout.

### INSTALLATION OF UNIT

To assist in grouting and leveling, the unit should be set on wooden blocks (approximately 1" high) located close to the foundation bolts. After unit is assembled the frame should be leveled at both ends of the gear reducer and at the front beam, which supports the samson post front legs. The unit should then be lined up with the well. The horsehead is easily aligned with the well by using a plumb bob hanging from the top of the horsehead. Be sure to allow for half the wire line diameter.

When the unit is properly aligned with the well the frame should again be checked to make sure it is level and the pitmans should be checked with a level to make certain they are vertical. For long trouble-free service, it is most important that the unit be properly aligned with the well and is level on the foundation. The four-way adjustment on the saddle bearing assembly and the adjustable horsehead serve to make this job easier.

When tightening the U-Bolts, used in attaching various assemblies, both ends of the U-Bolt should be drawn tight at the same time. ( Do not tighten one side fully tight before tightening the other. )

After the unit has been thoroughly checked and is properly installed, the frame should be grouted in. It is well to bear in mind that after the unit is grouted in, it cannot be moved on the foundation without considerable expense.

### WIRE LINE ALIGNMENT

Care should be taken to make certain the polished rod hanger is properly centered on the wire line. Normally the polished rod hanger will center itself but occasionally it is necessary to center it at the time of installation to make certain both wire lines are subject to equal loads.